

# Design of Diffractive Optical Elements for Augmented/Virtual Reality Applications

Simulation and Design Using RSoft Tools



# Outline

- Introduction
- Synopsys Solutions for AR/VR
- Design Case 1 – Diffractive Slanted Grating
- Design Case 2 – DOE on planar waveguides
- Conclusion

# Virtual Reality (VR)

- VR embeds our senses with a 3D, computer generated environment
- This environment can be interacted with and explored



# Augmented Reality (AR)

- AR enhances your existing natural environment by overlaying virtual information on top of it
- Both worlds harmoniously exist, providing users a new and (hopefully!) improved natural world where virtual information can provide assistance to everyday tasks

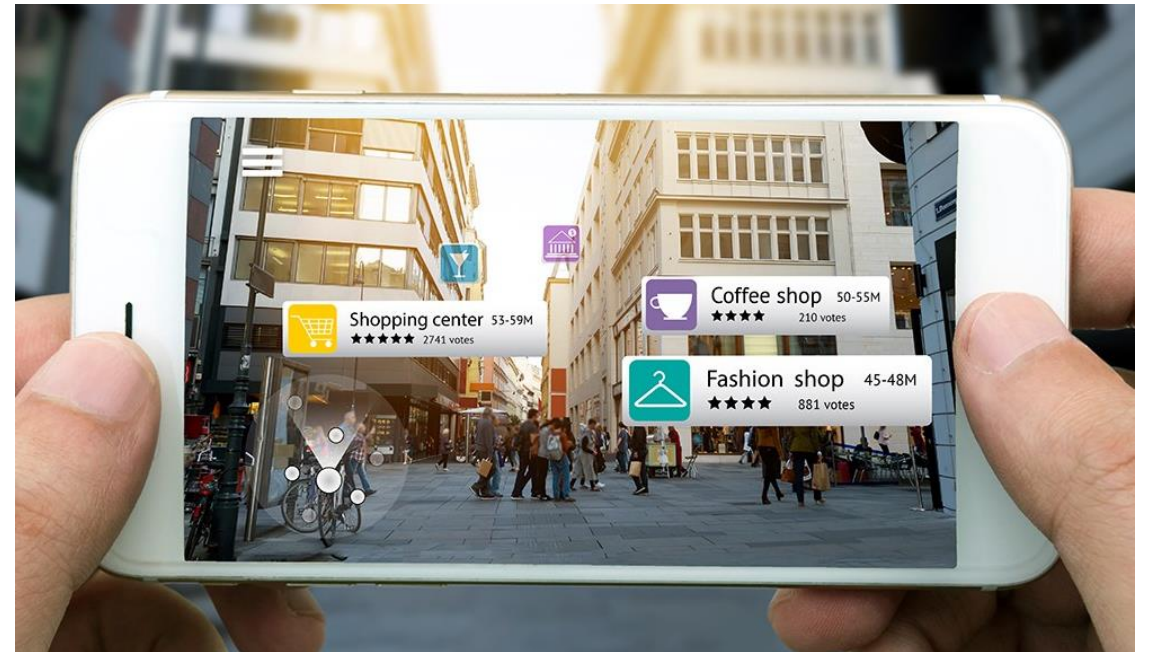

# Estimated VR/AR Market

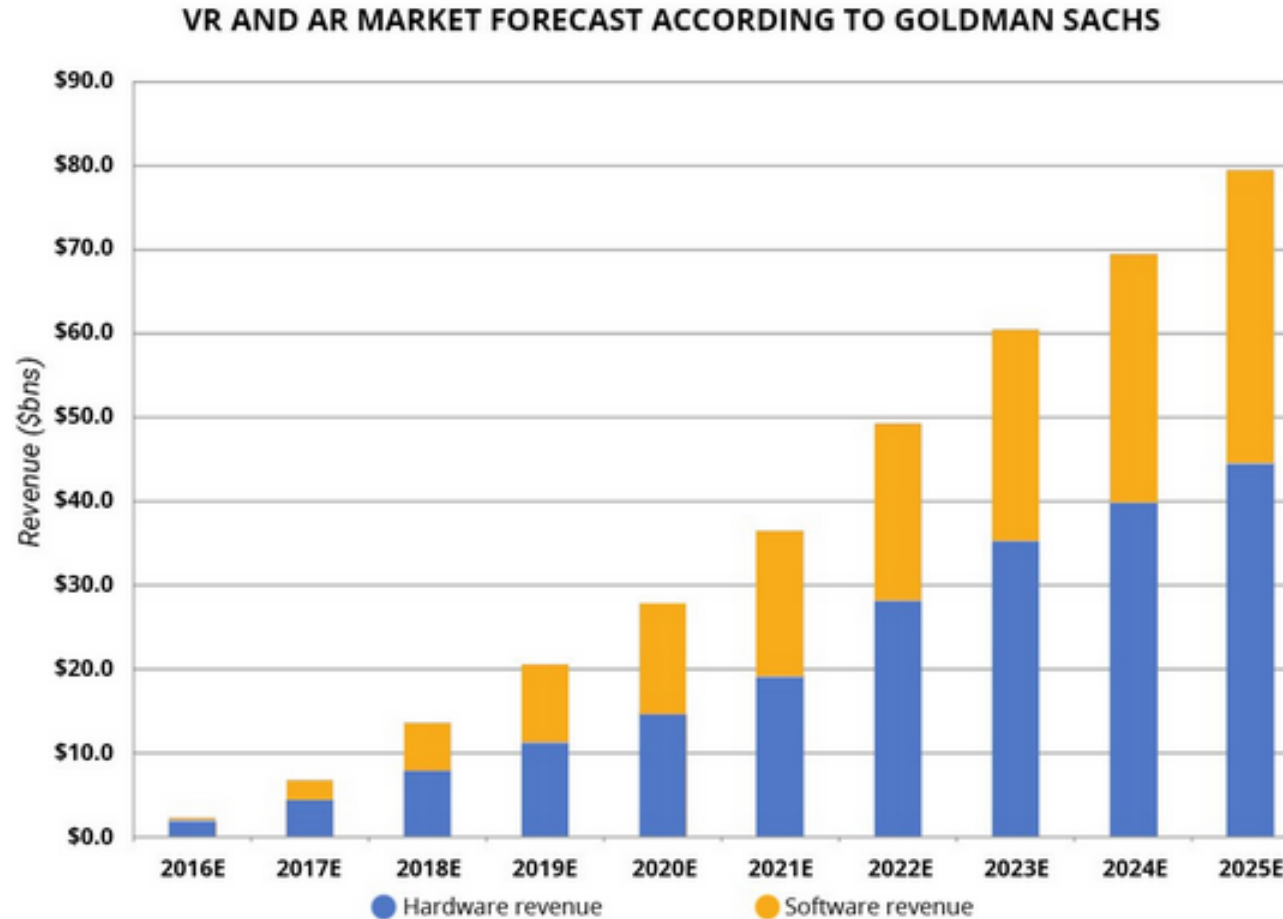

- VR and AR has potential to revolutionize many aspects of human life, and is projected to have extremely strong growth

# Optics is Key for VR/AR

- *“Optics remains the key challenge in developing the ultimate virtual experience”*

**Bernard Kress, Microsoft's HoloLens Division @ SPIE Photonics West 2018:**

- New types of optical and photonics technologies need to be implemented in next-generation VR/AR systems in order to achieve a better sense of display immersion for the user, and provide greater visual comfort for prolonged usage



# AR/VR Requirements

- Main VR/AR requirements:
  - Low weight
  - Small Size
  - Insensitive to vibration
  - Comfortable
- Types of existing systems include:
  - Freeform optical prism projection systems
  - Retina scanning
  - Reflective systems or hybrid reflective/refractive systems
  - **Optical planar waveguides with diffraction gratings**
    - This system has potential to meet AR/VR design requirements
    - Synopsys tools can be used for the design process!

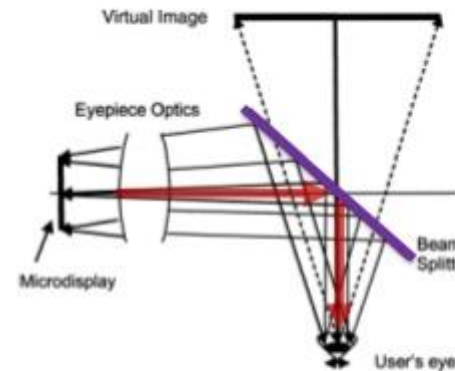
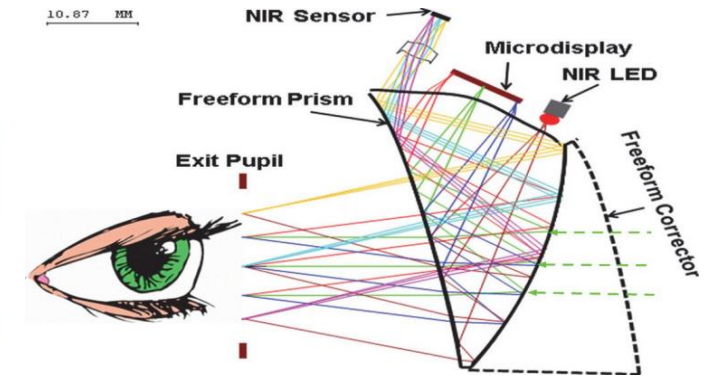
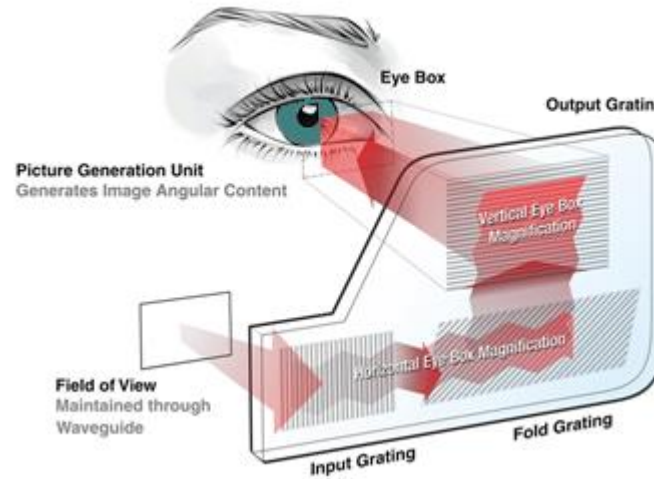

Head Mounted Display

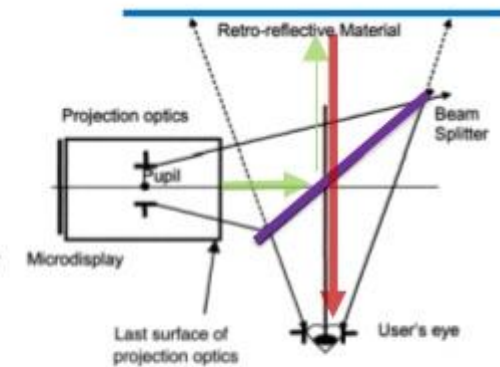

Head Mounted Projected Display

# Basic Schematic of Optical Waveguide System

## *Near-Eye-Display (NED) Systems*

- Functions of the Diffractive Gratings:
  - Couple light into waveguide plate and couple light out of plate into eyes
  - Wavelength selection
  - Wavefront reshaping
- Gratings must be designed properly so that the optical system produces good images

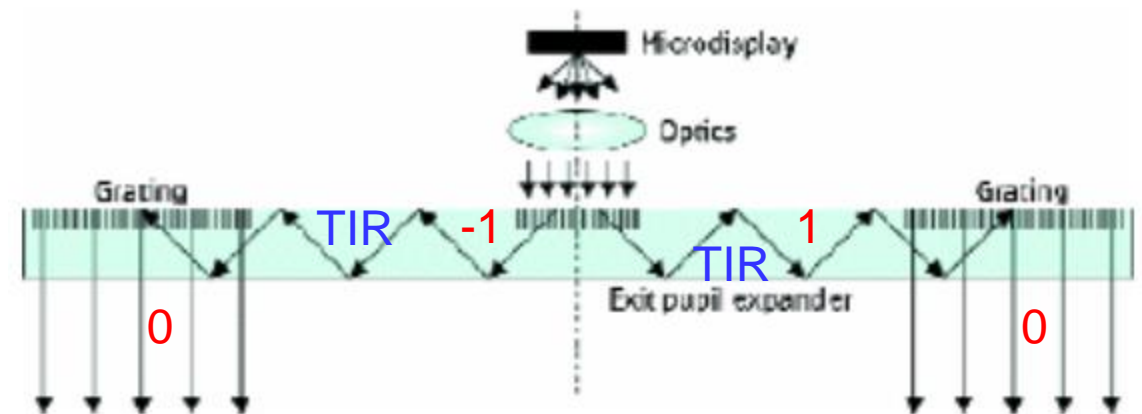
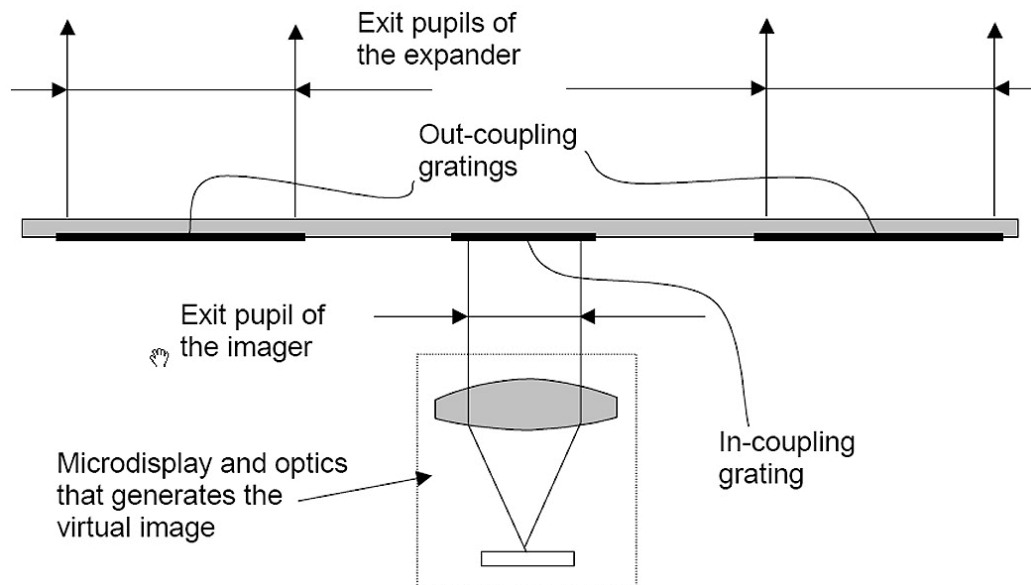



# Analyzing Gratings using Diffraction Theory

- k vector of incoming light:

$$k_i = \frac{2\pi}{\lambda} n_0 (\sin \theta_0 \cos \varphi_0, \sin \theta_0 \sin \varphi_0, \cos \theta_0),$$

- k vector of  $A = m^{th}$  diffraction order inside the waveguide:

$$k_m = \frac{2\pi}{\lambda} n_1 (\sin \theta'_m \cos \varphi'_m, \sin \theta'_m \sin \varphi'_m, \cos \theta'_m),$$

- From the grating equations in conical geometry:

$$n_1 \sin \theta'_m \sin \varphi'_m = n_0 \sin \theta_0 \sin \varphi_0 = \gamma$$

$$n_1 \sin \theta'_m \cos \varphi'_m = n_0 \sin \theta_0 \cos \varphi_0 + m \frac{\lambda}{T} = \alpha_0 + m \frac{\lambda}{T}$$

- Assuming the 1<sup>st</sup> order must TIR in the waveguide, the largest period that we can use is given by:

$$T < \frac{\lambda}{\sqrt{1 - \gamma^2} - \alpha_0}$$

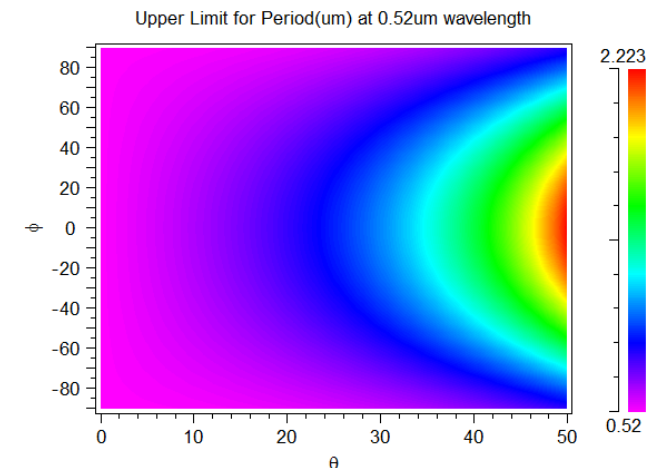
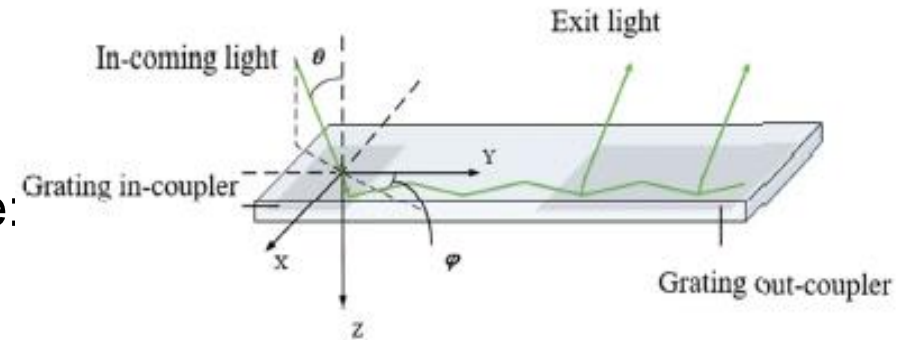

# Analyzing Gratings using Diffraction Theory

- Furthermore, consider the requirement that there are no orders higher than the +/-1 order, the waveguide indexes are bounded by:

$$\sqrt{\gamma^2 + \left[\alpha_0 + \frac{2\lambda}{T}\right]^2} > n_1 > \sqrt{\gamma^2 + \left[\alpha_0 + \frac{\lambda}{T}\right]^2}$$

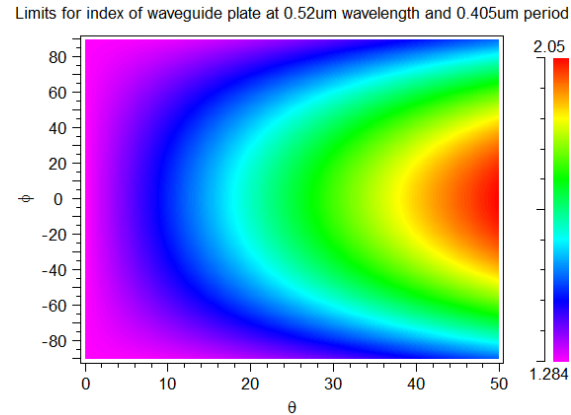
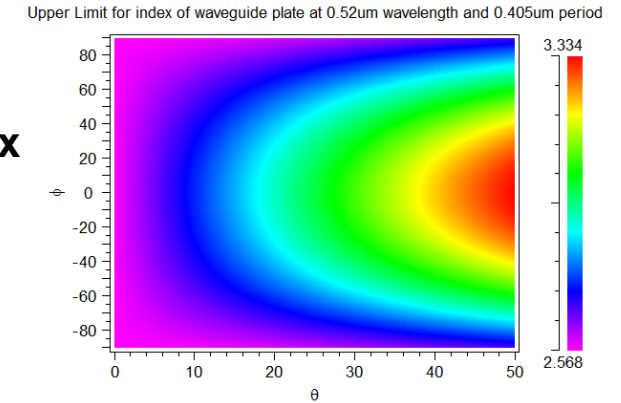

Plate Index  
 $< n <$



- This simplistic approach is not enough, the actual grating geometry must be optimized to achieve a realistic grating that works in real operating conditions. This includes:
  - Period
  - Diffraction Angle of each order
  - Diffraction efficiency of each order
  - Grating materials and geometry
  - Others...

# Synopsys Solutions for AR/VR



# Synopsys's Solution for AR/VR Optical System Design

- **Optical System:** Synopsys LightTools
- **Grating Design:** Synopsys RSoft
  - RSoft CAD / DiffractMOD / FullWAVE / MOST Optimizer

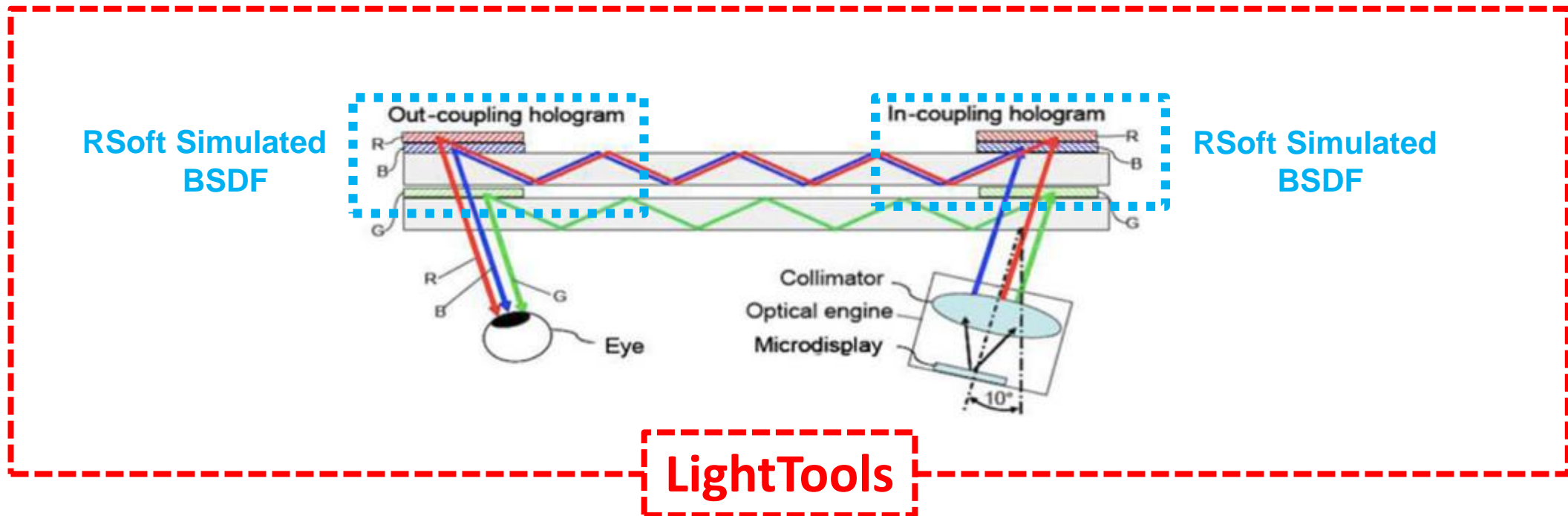

# DiffractMOD: RSoft's RCWA tool

- DiffractMOD is a very efficient tool to rigorously calculate diffraction properties of transversely periodic devices
- DiffractMOD outputs :
  - Reflection/Transmission power for each diffraction order
  - Total reflection/transmission
  - Amplitude/Phase/Angle for each diffraction order
  - Field distribution in simulation domain

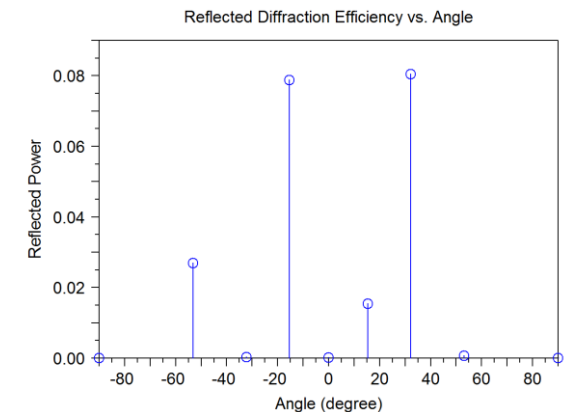
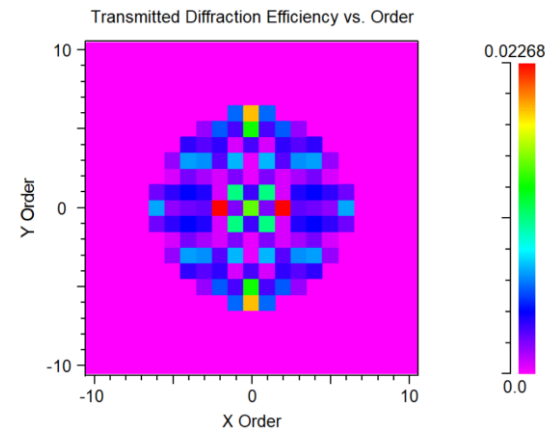
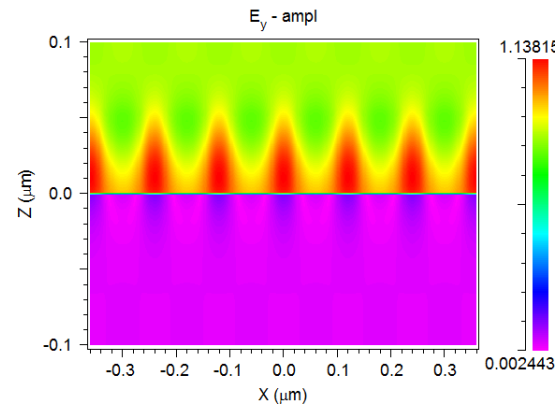
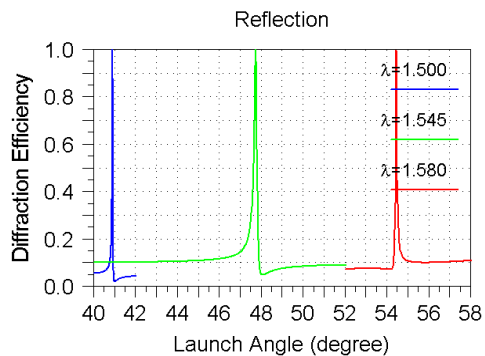
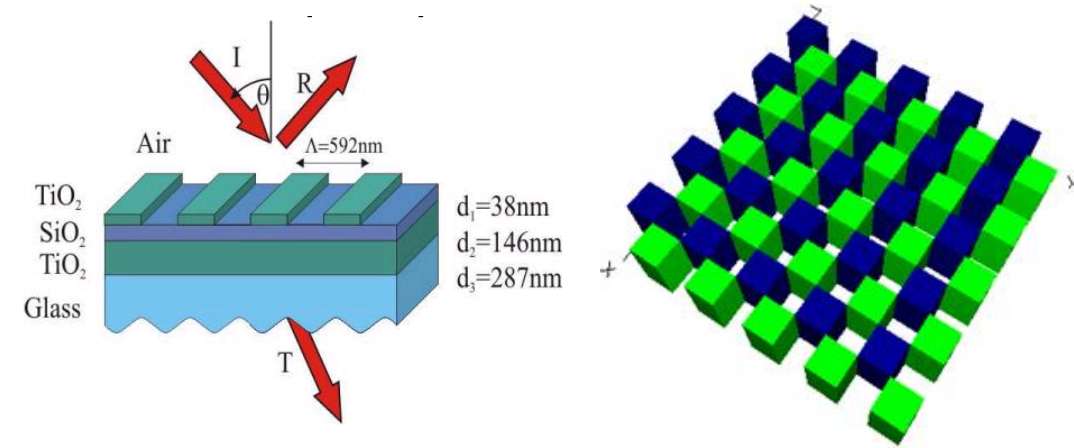

# RSoft and LightTools Co-Simulation

## • RSoft Component Tools

- Based on physical optics
- Maxwell's equations, etc
- Small photonics devices
- Wave propagation and multi-physics
- Diffraction, polarization, nonlinearity, electro-optical, thermo-optics, etc.

## • LightTools

- Based on geometrical optics
- Snell's law, etc.
- Large bulk optical system
- Ray tracing and beam propagation
- Reflection, refraction, diffraction

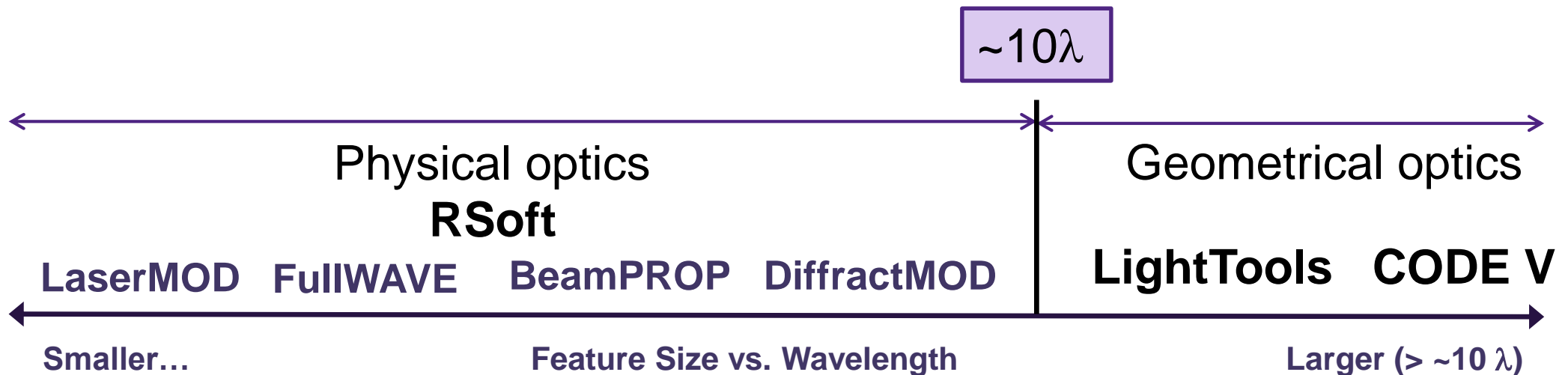

# RSoft/LightTools BSDF Interface

- RSoft BSDF files:
  - Automatically calculated using RSoft's FullWAVE or DiffractMOD packages
  - Contains information about how a surface (thin film, patterns, etc.) scatters light
  - Reflection/transmission data is stored for illumination from both sides of the surface
  - Scatter information is stored as a function of two incident angles, wavelength, and polarization
- The RSoft BSDF file is then used in LightTools to define a surface property
  - Rays that hit the surface in LightTools are 'diffracted' according to the data in the RSoft BSDF file

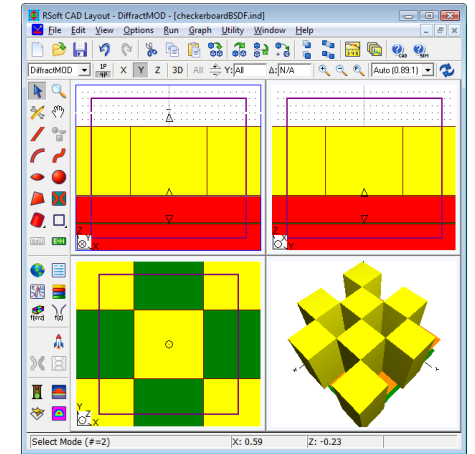
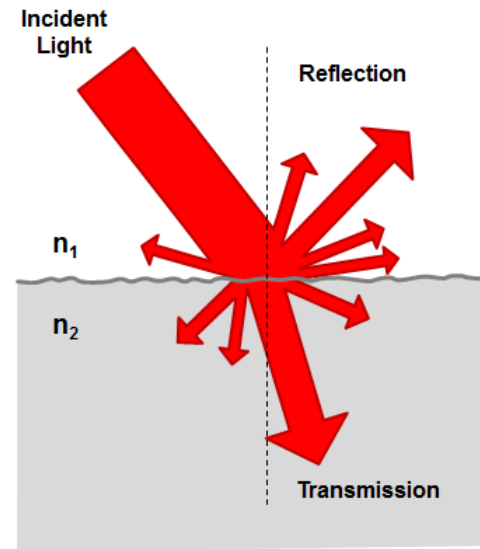

Periodic Nano-structure

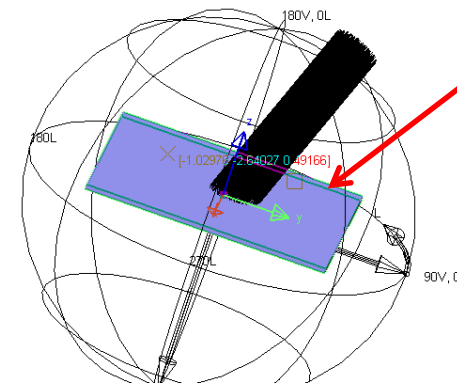

Light incident on BSDF surface

BSDF Surface

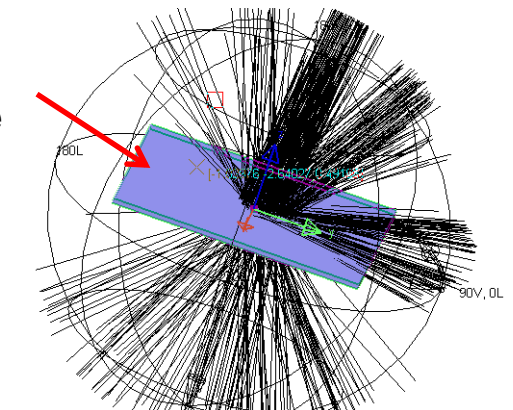

Scattering from BSDF surface

# Design Case 1 – Diffractive Slanted Grating



# Design Case 1: Structure Overview

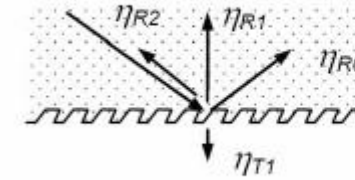
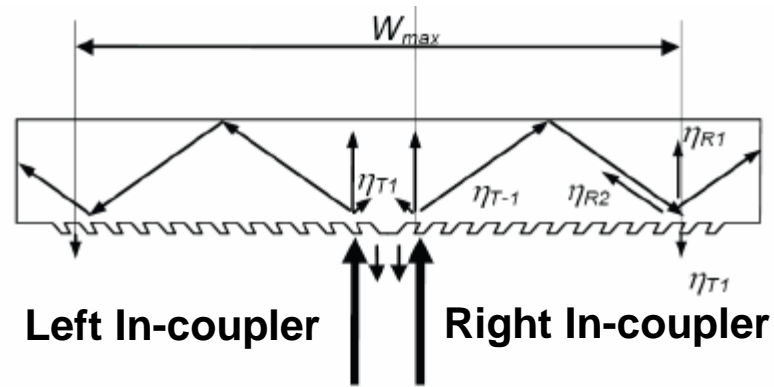
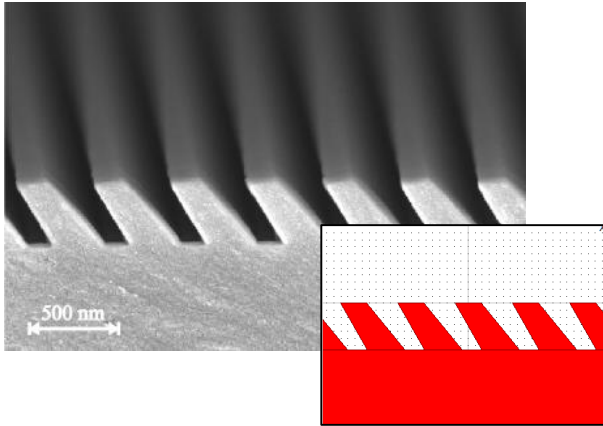

Reflection Type  
Out-coupling

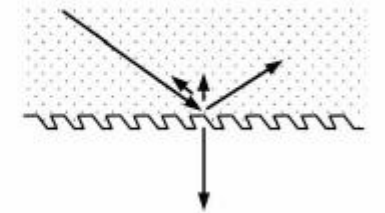

Transmission Type  
Out-coupling

- Diffractive slanted gratings are manufactured onto a high refractive index plastic waveguide with simple UV replication technology. Large quantity manufacturing is possible.

- The slanted gratings can be optimized to have high 1<sup>st</sup> order transmission efficient for right in-coupling and high -1<sup>st</sup> order transmission efficient for left in-coupling (> 92%).

- Two types of slanted gratings for out-coupler. The efficiency can be optimized as well.

# Using DiffractMOD for Grating Design

- Grating Properties:
  - **Wavelength:**  $0.52\ \mu\text{m}$
  - **Period:**  $0.405\ \mu\text{m}$
  - **H:** grating height
  - **A:** slant angle
  - **L:** Left slope angle from slant axis
  - **R:** right slope angle from slant axis
  - **Fill:** duty ratio
  - **Index:** 1.716

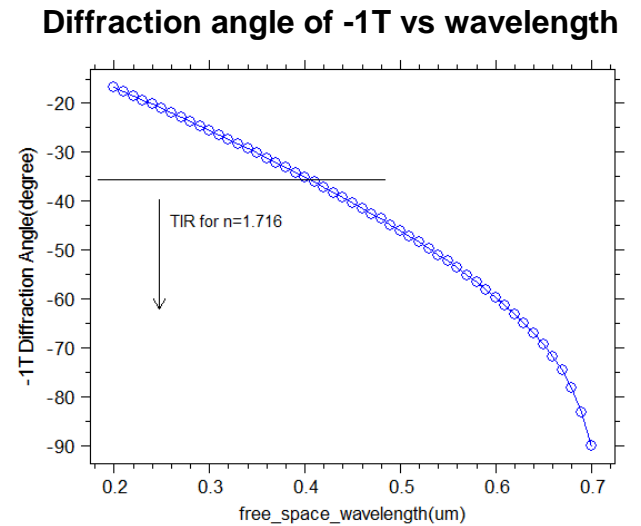
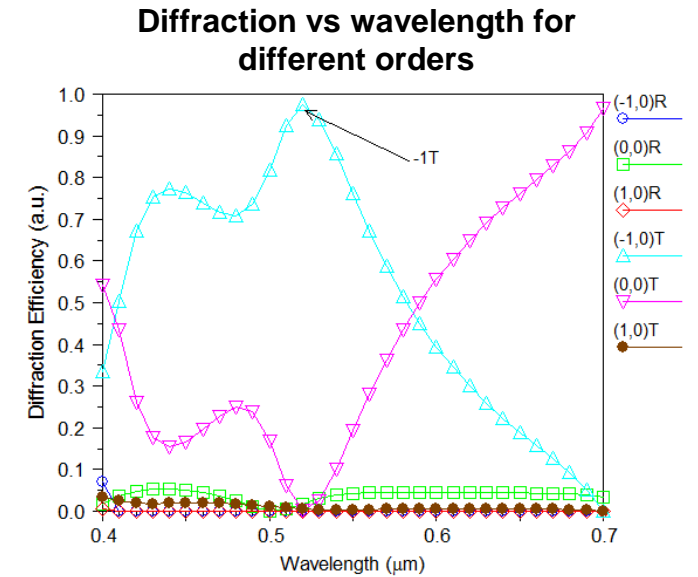
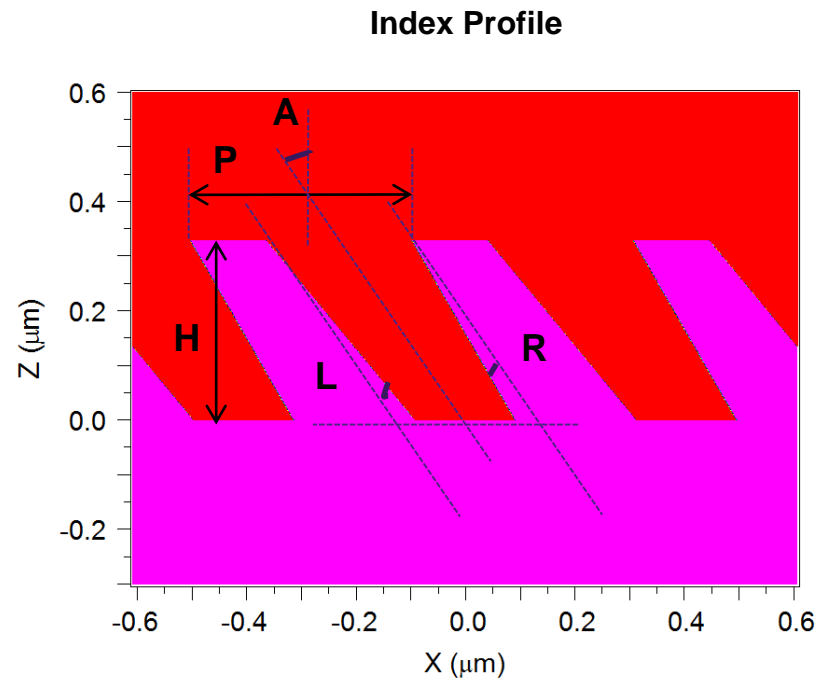

# Simulation Results

## Reflection vs. Transmission Type Gratings

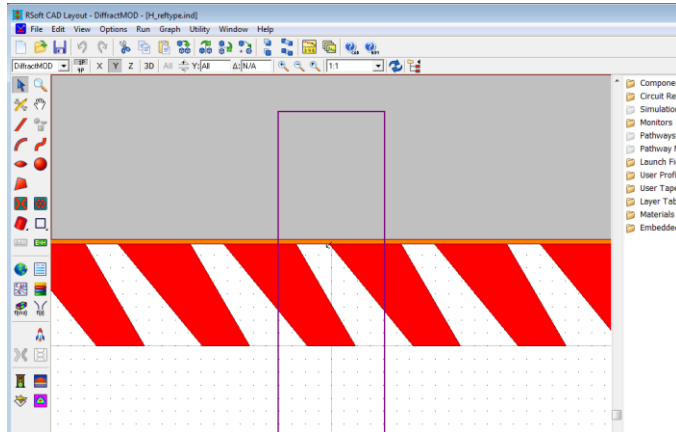

Reflection Type

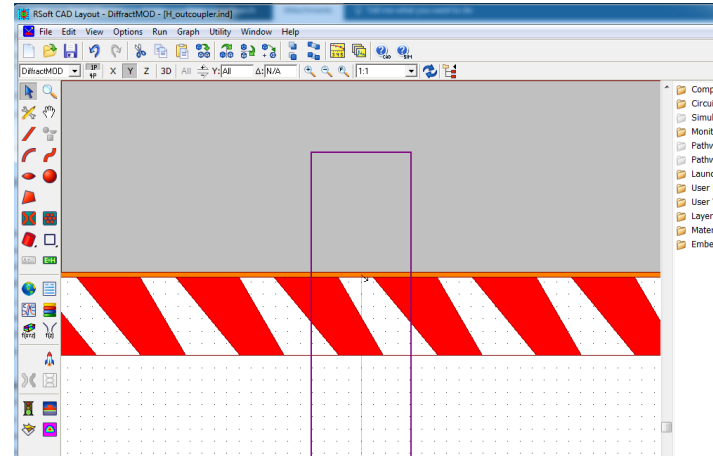
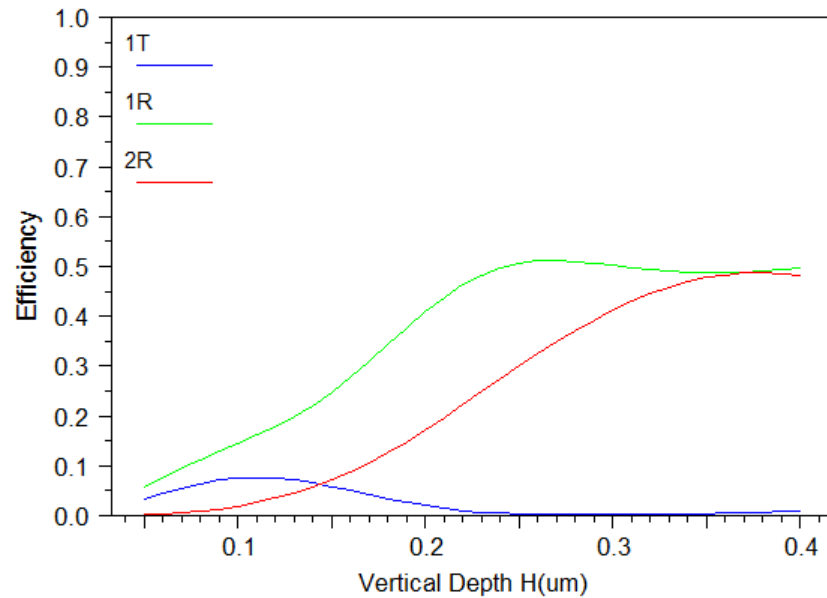

Transmission Type

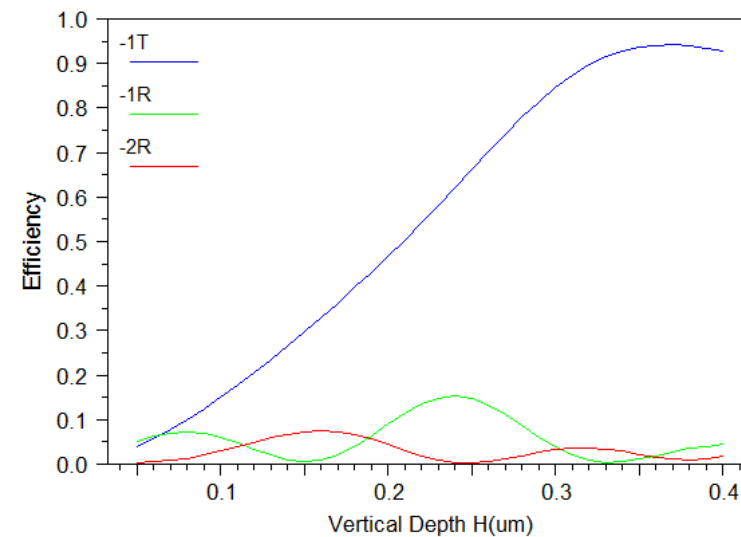

# Exploring Parameter Space with MOST Scanner

- RSoft MOST scanner is a very powerful tool to investigate structure parameters
- In this case, maximum power in the +1 (right in-coupler) and -1 (left in-coupler) are desired

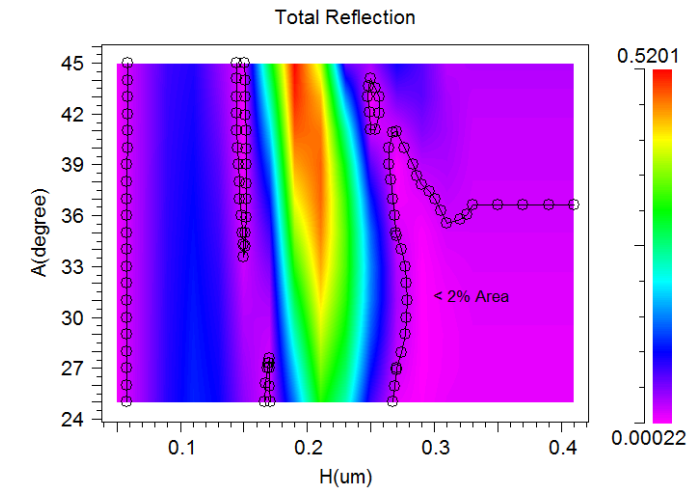
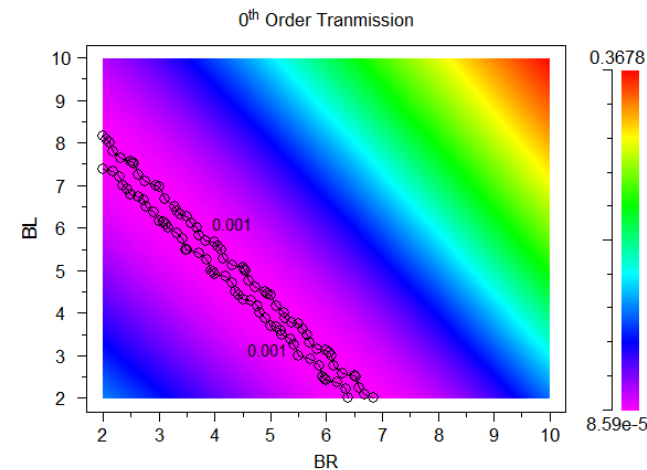
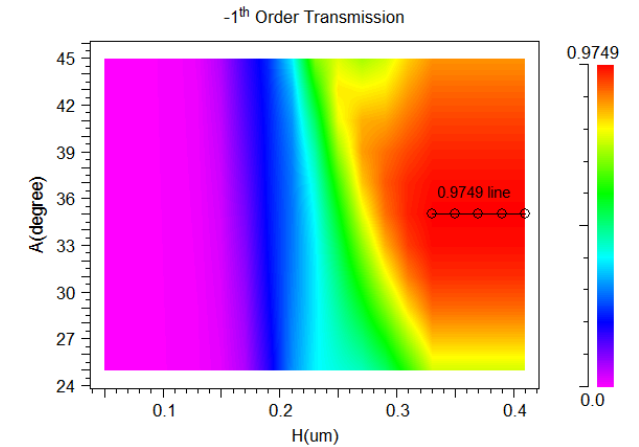
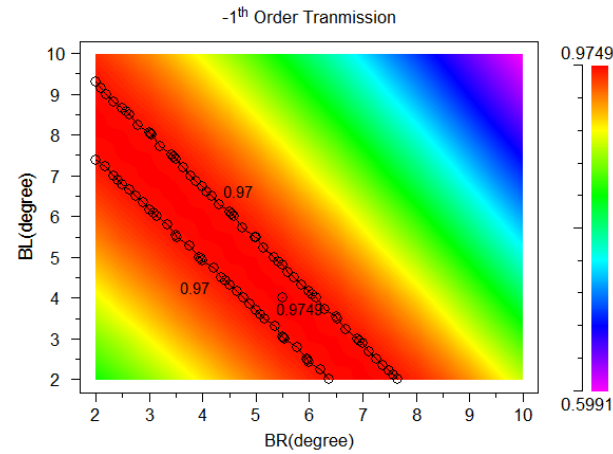
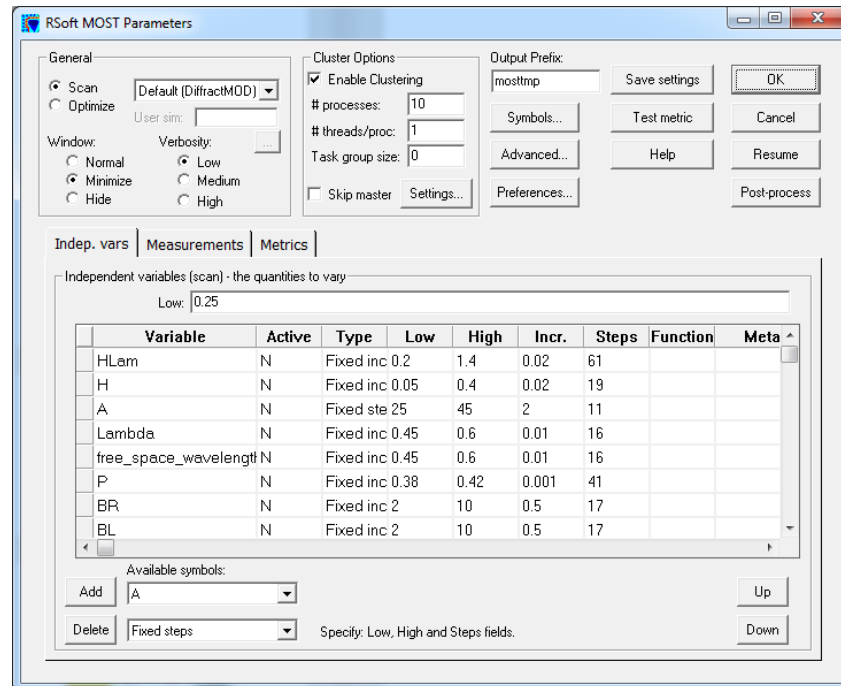

# Finding Optimal Structure with MOST Optimizer

- MOST Optimizer uses a genetic algorithm to explore the parameter space
- A Python function was used to maximize the power in the -1 order
- The geometry for the starting point and final optimal point are shown

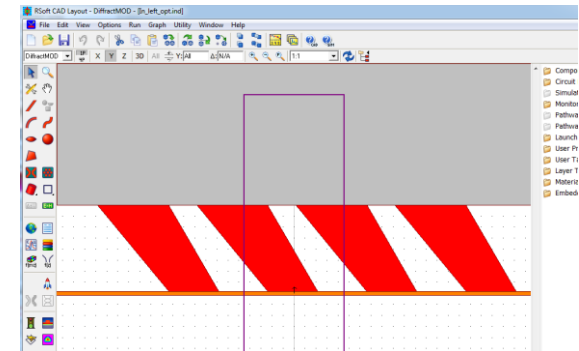

Optimizer finds a structure that meets the target function

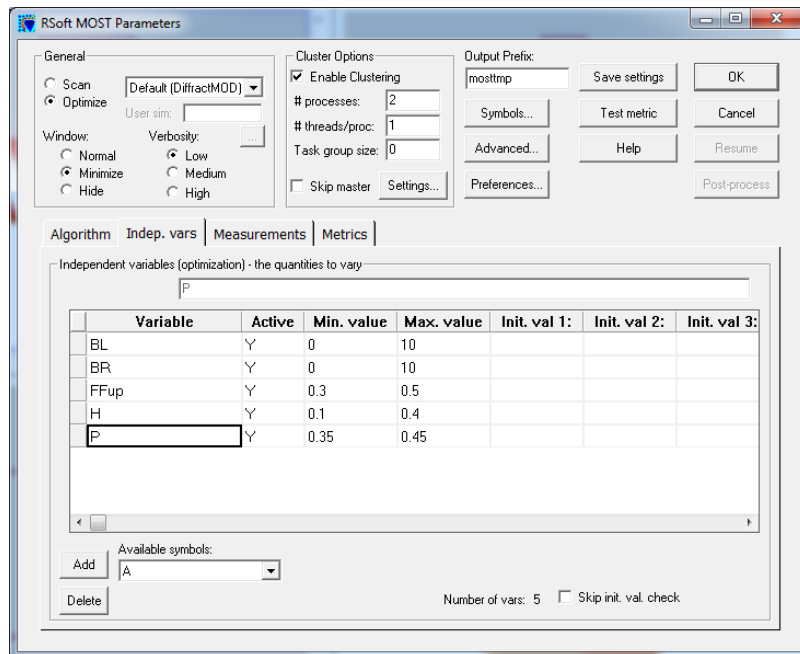
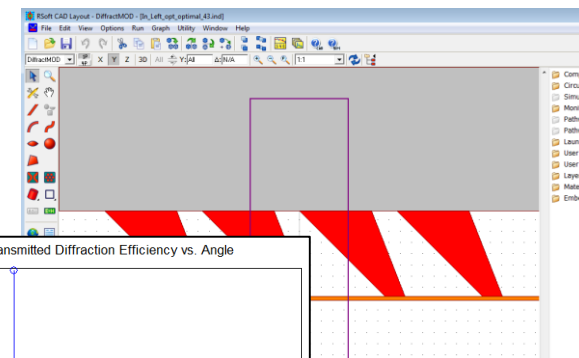

## Target Function (Python)

```
def dm_met(measurements, symtab, extras):
    '''Python Function for metric'''
    print ('\nRunning Metric:')

    #Read R/T order measurements
    #r_orders= measurements['r_orders'].data()
    t_orders= measurements['t_orders'].data()

    #print r_orders
    #print t_orders

    #Metric:
    err0= abs(1 - get_de(t_orders,-1,0))

    ans= err0
    print 'Err0:',err0

    print 'Returning: ',ans
    return ans

#####
#USEFUL FUNCTIONS
def get_de(array,x,y):
    '''Return de for x,y order from array'''
    #Find X/Y size of array (requires odd size)
    xorders=(array.shape[0]-1)/2
    if (len(array.shape) == 1):
        yorders=1
    else:
```

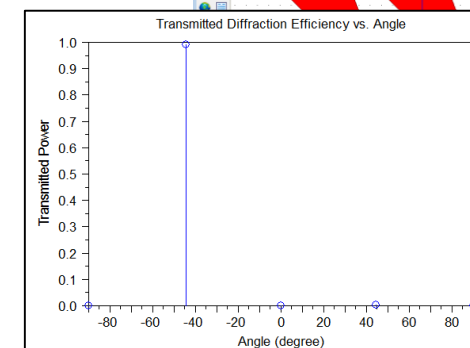

# RSoft BSDF Calculation for Optimal Structure

- Angular range of RSoft BSDF file:
  - **Phi** (from normal): Range of [0,90] with 1° spacing
  - **Theta** (around normal): Range of [0,360] since the structure is anisotropic with 5° spacing
- BSDF Utility runs DiffractMOD simulations and both polarizations are automatically calculated

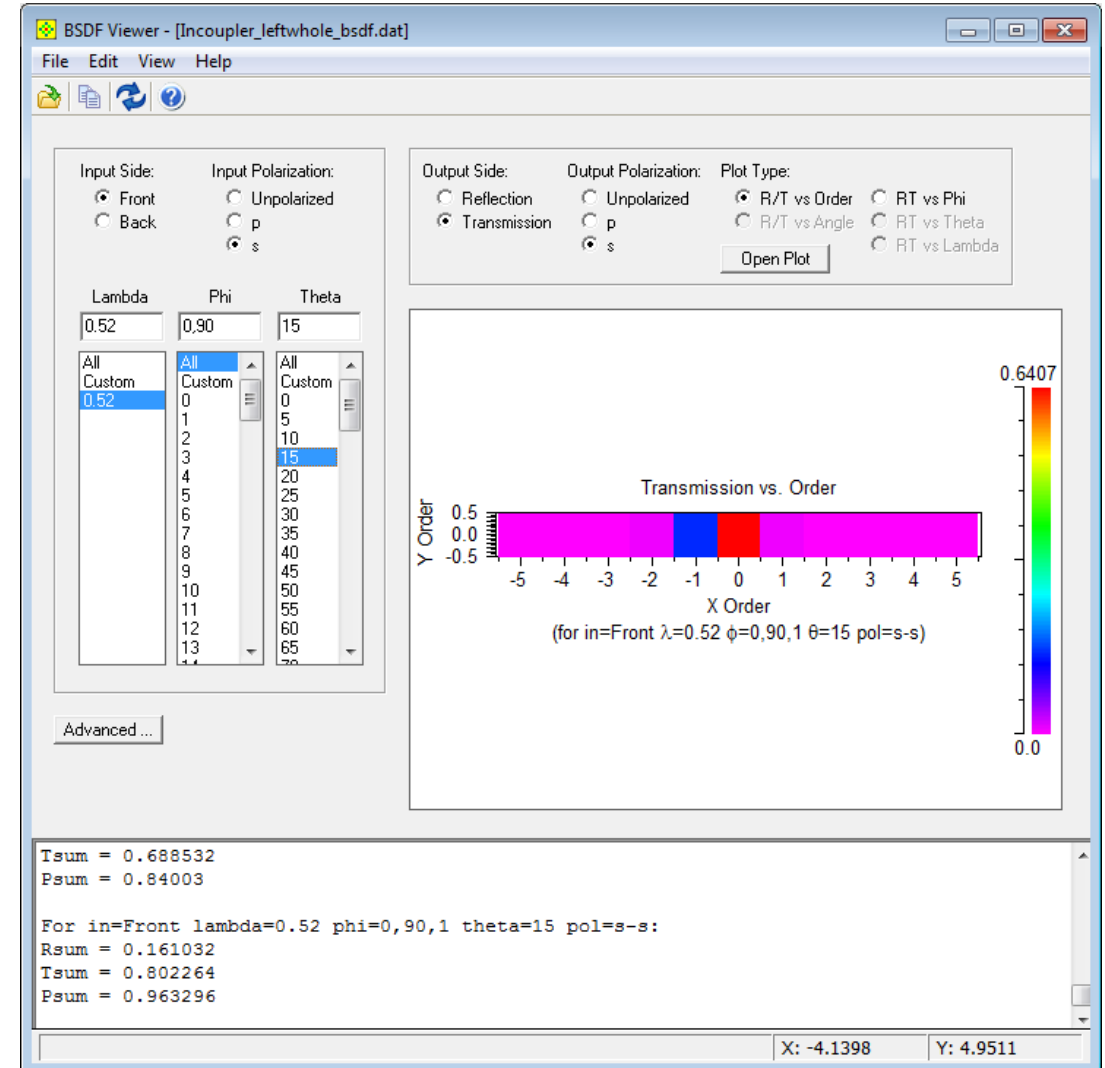
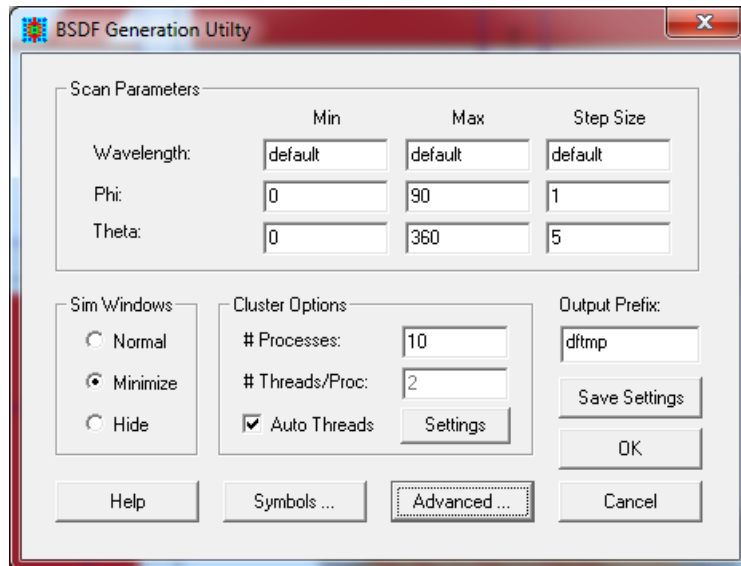

# Using RSoft BSDF files in LightTools

- RSoft BSDF files were calculated for each grating and assigned to the appropriate LightTools surface
- Test rays were used to verify that the basic design worked

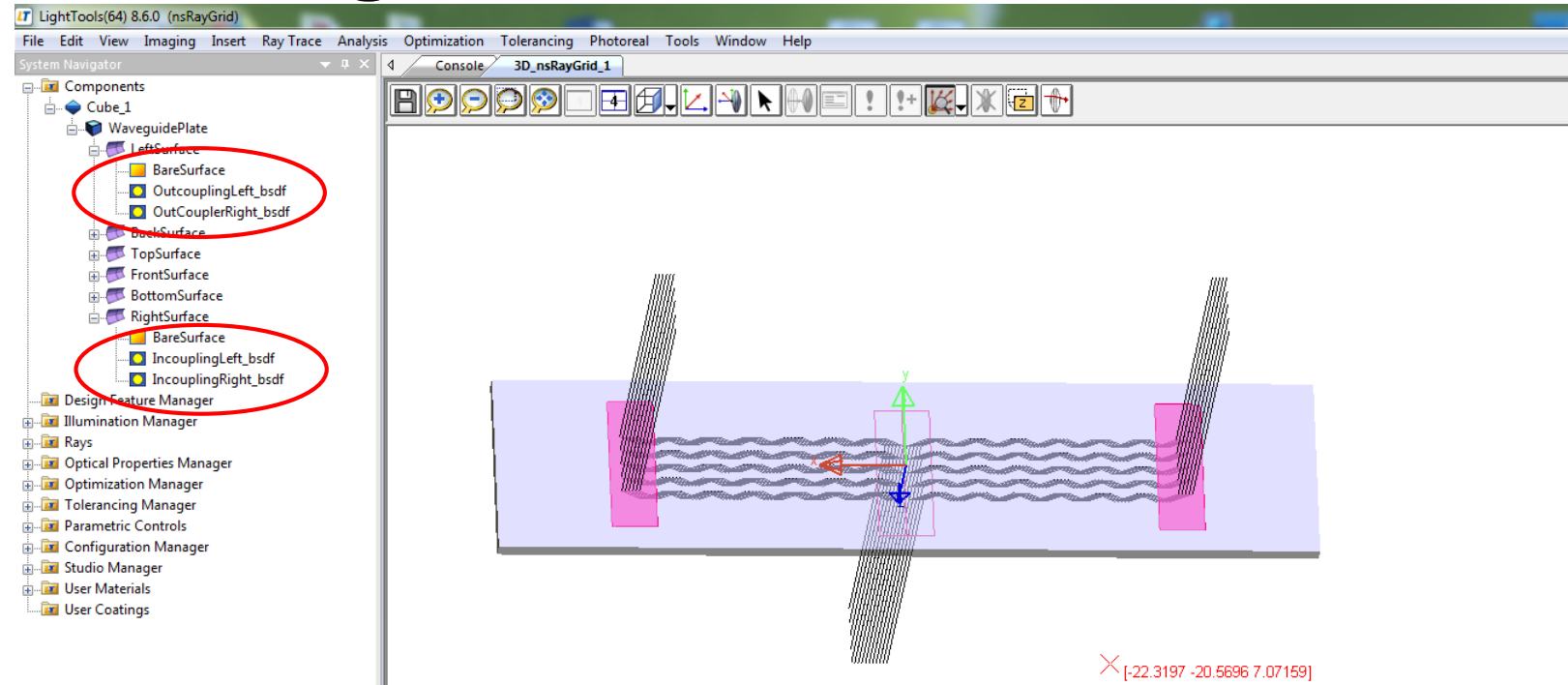

Numeric Parameters		
	Name	Value
1	Power Threshold	1.0000e-010
2	Swap Front/Back	1.0000
End of Data		

String Parameters		
	Name	Value
1	RSoft BSDF File Name	Incoupler_leftwhole_bsdf.dat
2	Additional Options	
End of Data		

# LightTools/RSoft Co-Simulation Results

- A patterned hole array was used as a test image; the hole array image is clearly seen at both eyes
- The incident source has an angular spread of  $13^\circ$  while the grating was designed for collimated input
- The angular sensitivity of the grating can be explored to improve the uniformity of the device
- Possible improvements include:
  - Combined optimization of diffraction gratings
  - Free form optical systems



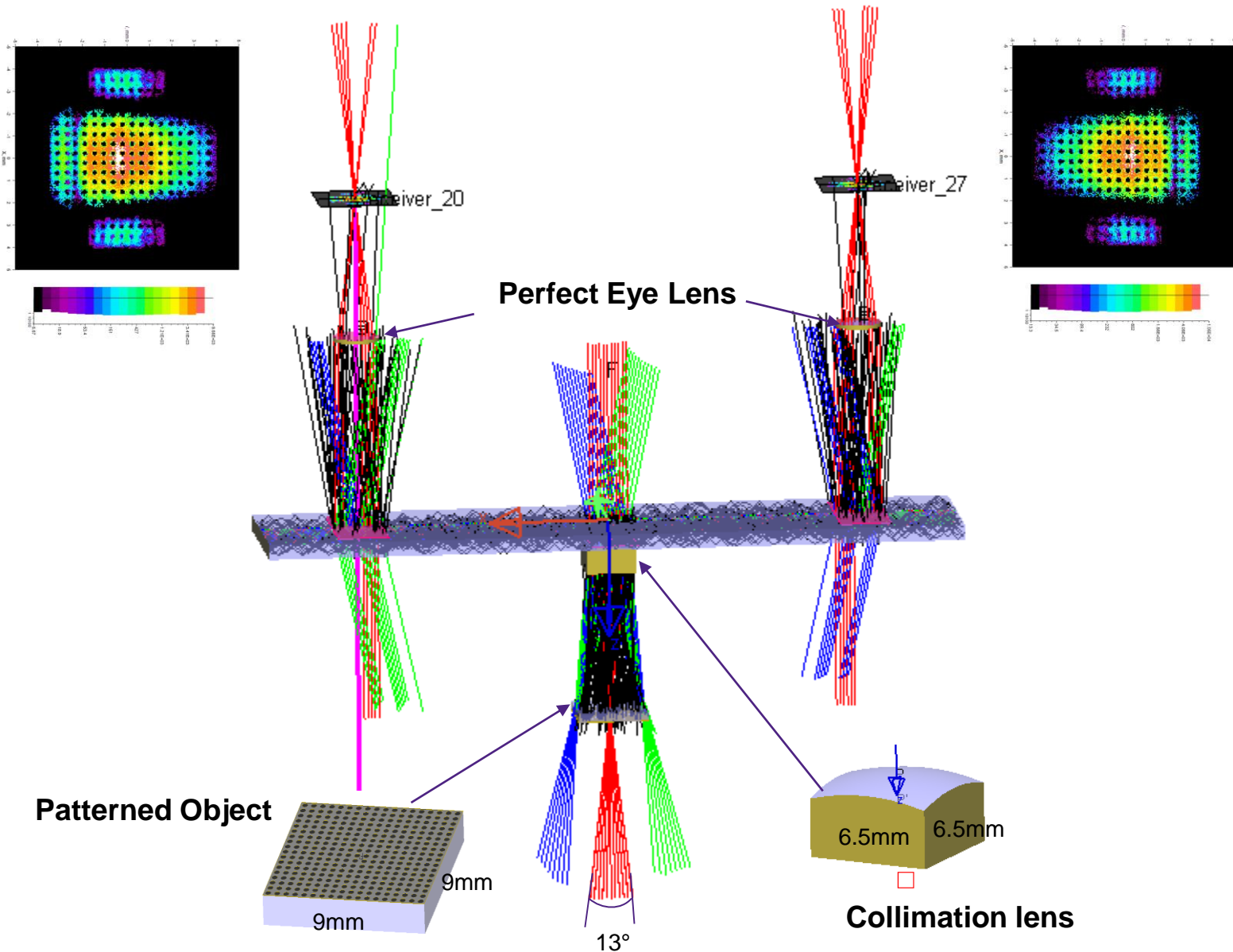

# Design Case 2 – DOE on planar waveguides

*By: Tung Yu Su, Cybernet System Taiwan*

# Design Case 2: Structure Overview

- Three grating groups will be included in this VR/AR system:

- **Input Grating:** Used to couple light into a substrate, diffracting light at an angle and making light propagate in the substrate by total reflection

- **Diffractive Exit Pupil Expander (EPE) Grating:** Used to expand the light

- **Output Grating:** Used to couple out the light from a substrate into air, guiding the light into other optics in the system

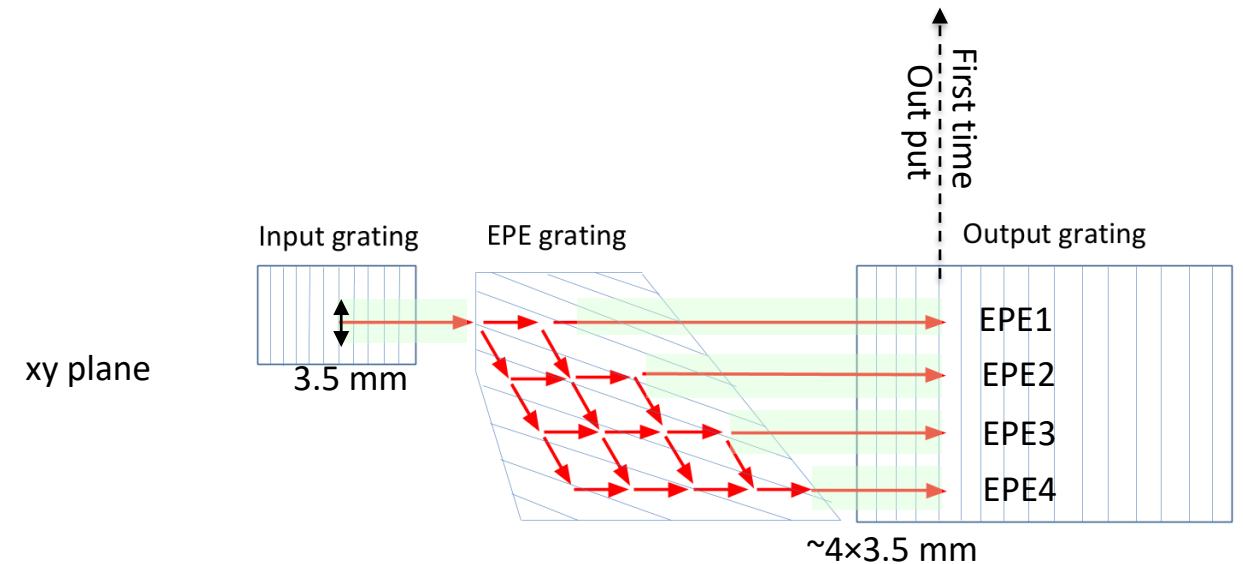
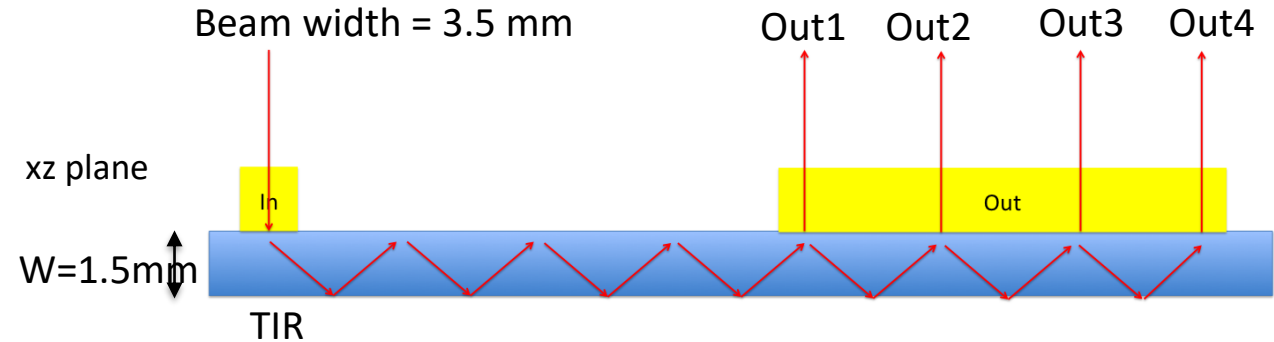

# Diffractive Exit Pupil Expander (EPE)

- The size of the waveguide structure can be minimized using a simple virtual image generator having a small exit pupil and an exit pupil expander (EPE)
- Here, we use an even number of first-order diffractions, which contains a input grating, a output grating, and a diffractive EPE to expand a single input beam to a 4 x 4 beam array in a very thin optical waveguide

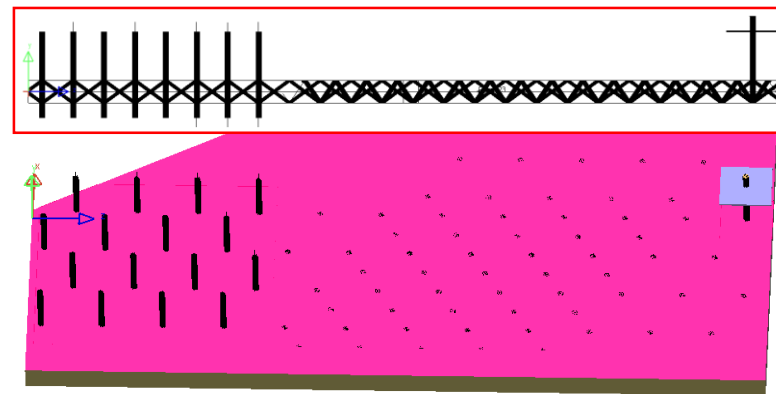
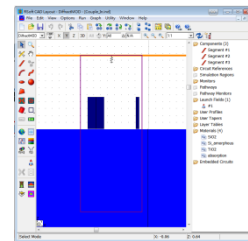
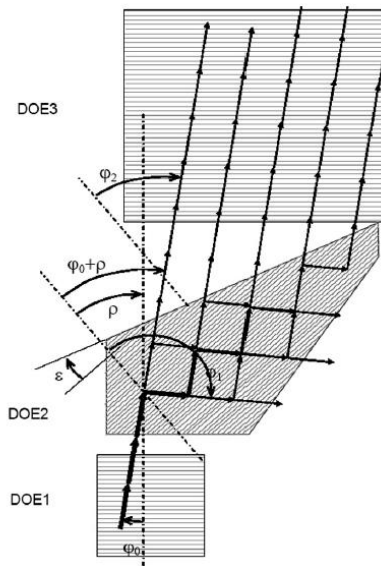

Output grating  
(beam array)

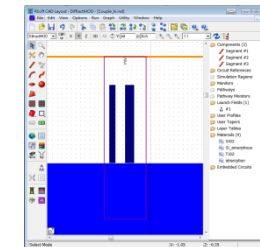
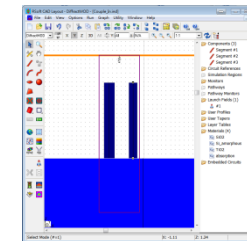

Input grating  
(single beam)

# Drawing the Input Grating in the RSoft CAD

- The prototype for the input grating is a 'line grating' since a single etch process can be used since the height of every fin is the same

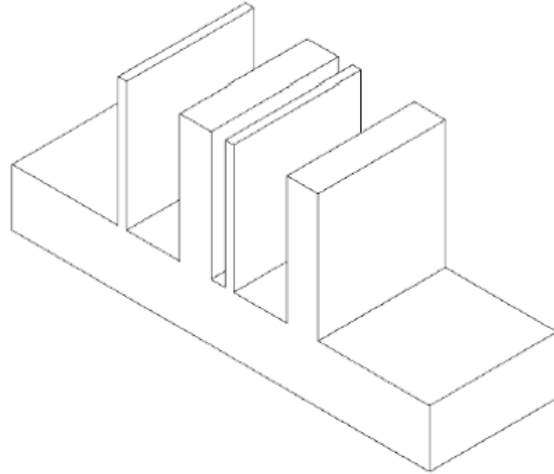

- Requirements for input grating:
  - Transmitted diffractive angle must be larger than the total reflection angle (TIR)
  - Transmission should be more than 70% for the incident angle range  $\pm 15^\circ$
- Structural Parameters:
  - Period (fixed to meet requirement of output diffractive angle)
  - Width
  - Height
  - Filling Factor
  - Index/Material

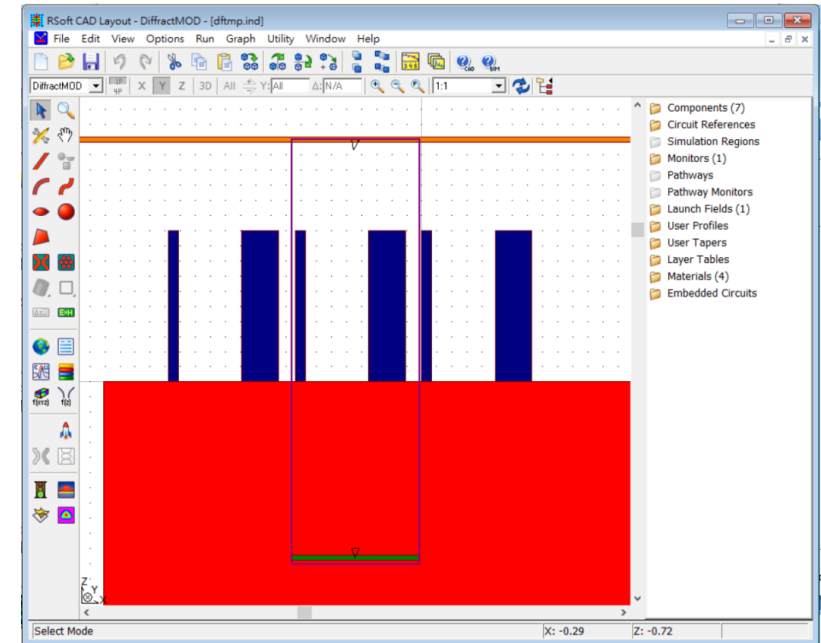

# MOST Optimization

- Before performing a successful optimization, a suitable error function should be clearly defined:
  - The target of this optimization is the ‘uniformity’ of transmitted power
  - The blue line (uniformity before optimization) should move towards the red line (target)
- A Simplex algorithm was chosen for this optimization study

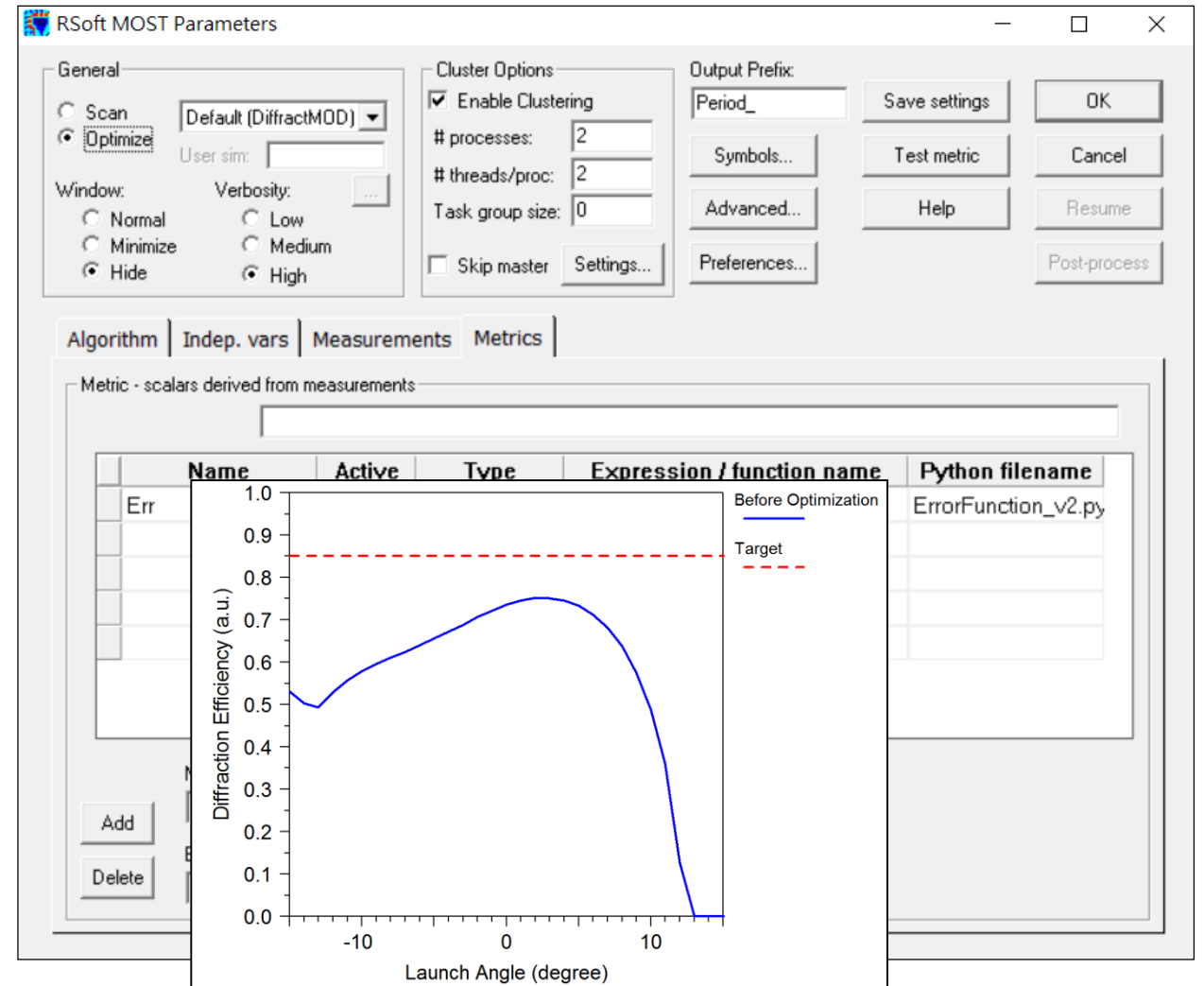

# Optimization of Input Grating

- Optimization details:
  - 150 steps (1583 simulations) were performed to find a converged result
  - 31 models were automatically saved during optimization; users are able to check the performance of every model
- Result shows increased transmitted power across  $\pm 15^\circ$  incident angular range, >70%

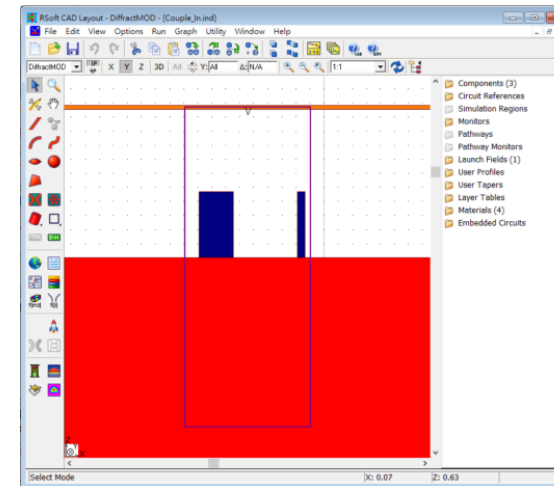
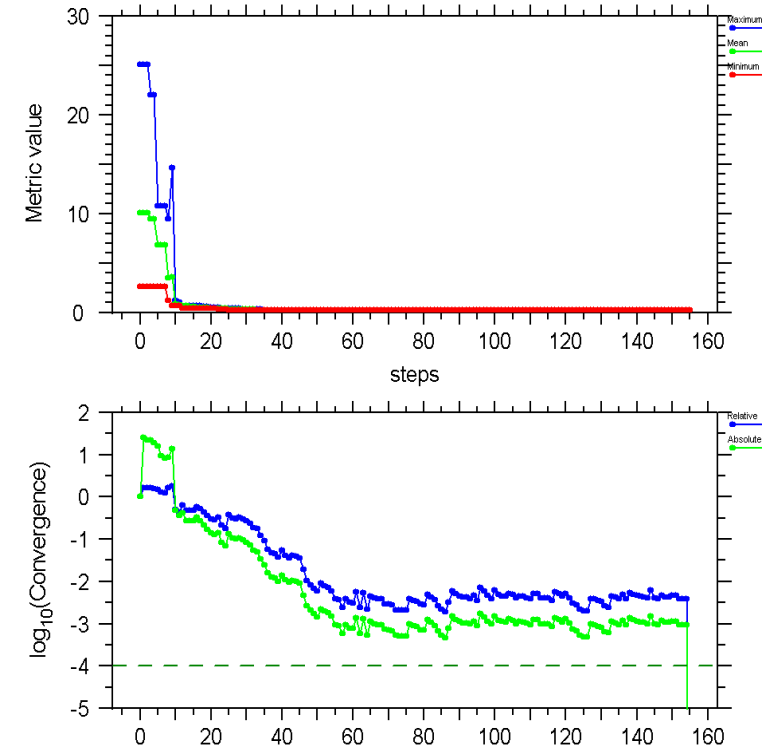
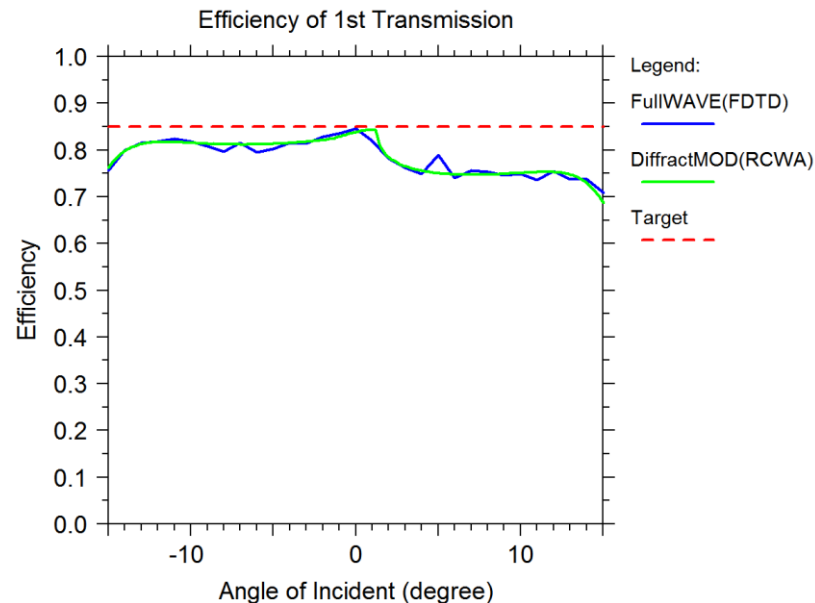

# Output Grating

- The output powers of “Out1”, “Out2”, “Out3” and “Out4” should be close to each other, keeping a good output power uniformity
- To achieve this target, a single grating is not sufficient: the Output area is divided into four areas
  - Each area has a different grating
  - Output power(s) can be properly designed

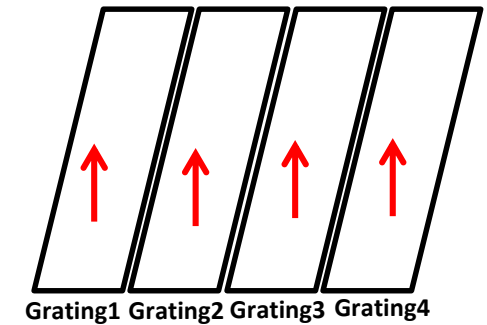
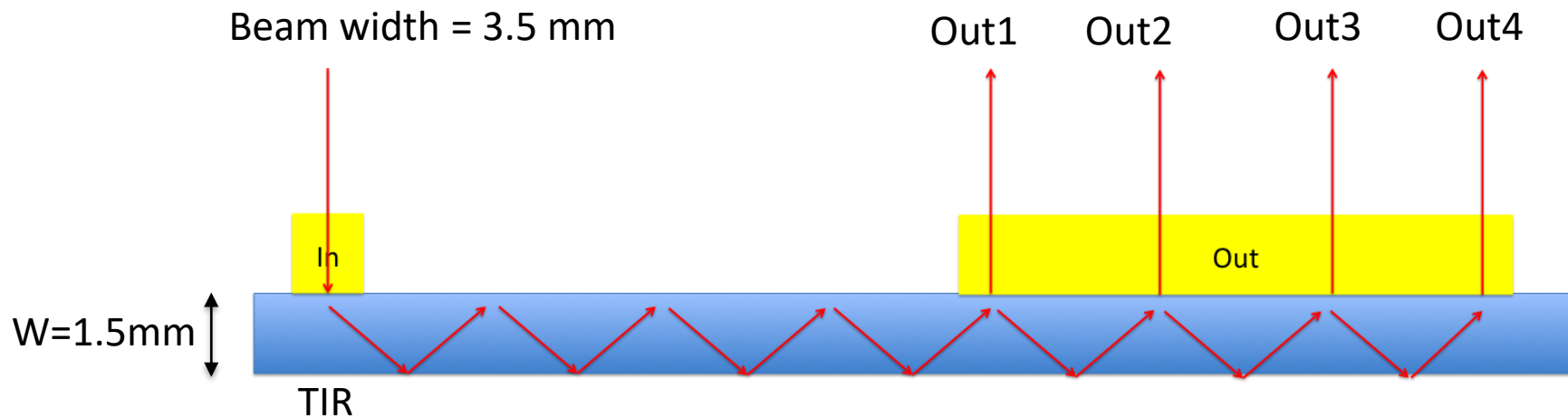

# Output Gratings

	Grating1	Grating2	Grating3	Grating4
Input Power	1	0.75	0.5025	0.25025
Diffraction Efficiency	25%	33%	49.8%	99%
Output Power for -1 <sup>st</sup>	0.25	0.2475	0.25	0.25
Power to the next area	0.75	0.5025	0.25025	0

- Goal: 25% of power output in each area which means that the -1<sup>st</sup> order must have different output power for each grating
- Here we fix these parameters of the four gratings:
  - Height (so only one mask is needed)
  - Material
  - Period
- Multi-variable optimization is needed again!



# Optimizations of Output Gratings

- Error functions are easy to define in RSoft's MOST:

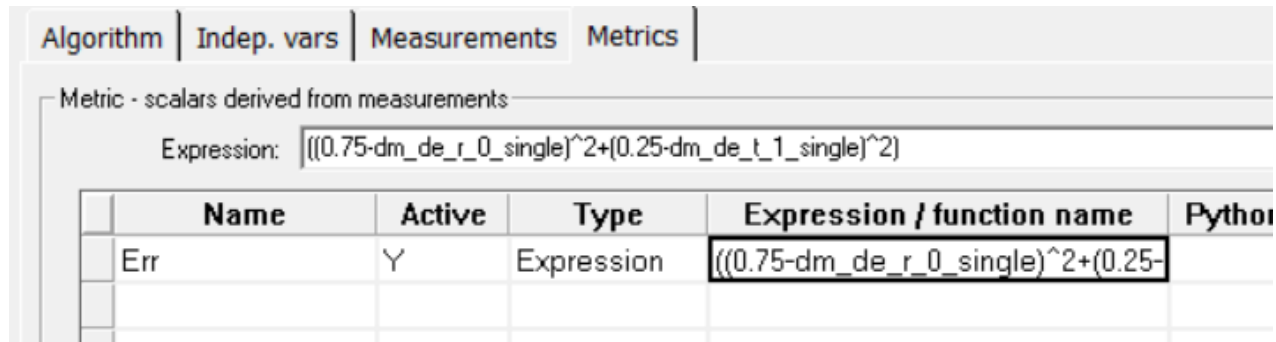

- Optimized models can be checked after optimization, geometry is shown here:

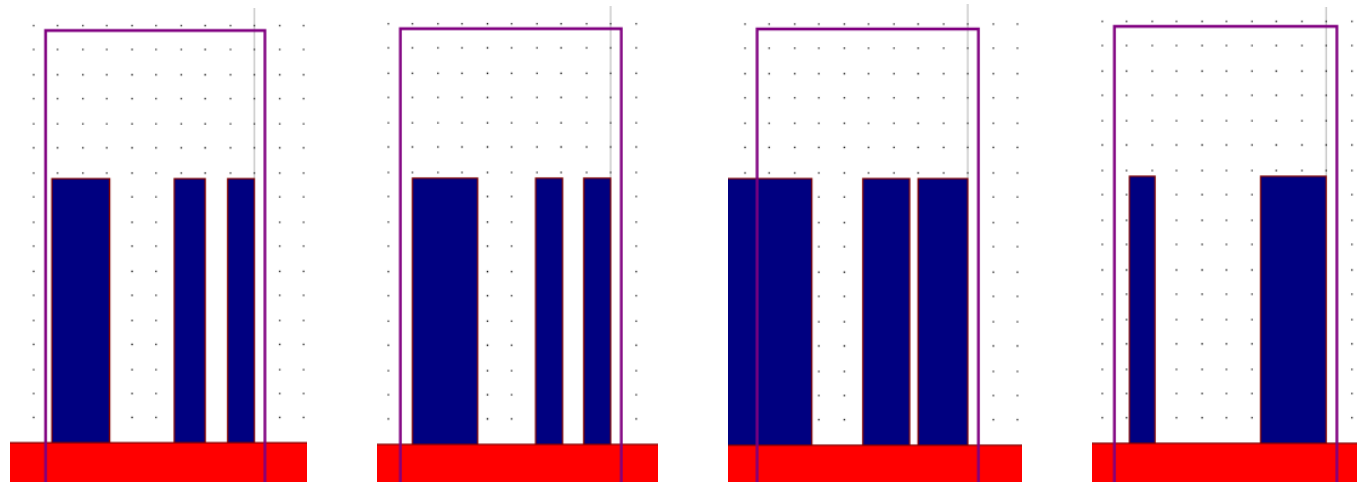

# Gratings for EPE

- The design of the EPE includes the second incident angle ( $\theta$ )
- The grating was designed to split the light as shown below

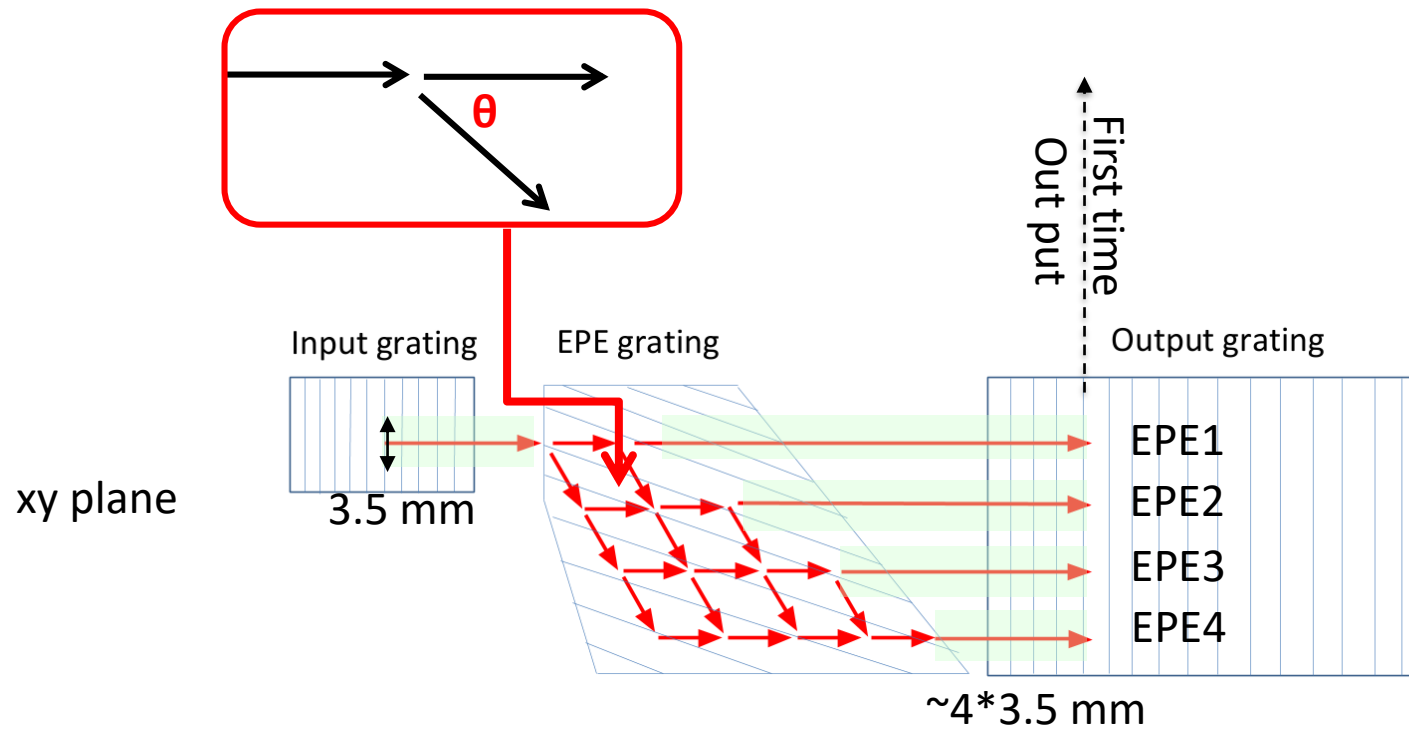

# Gratings for EPE

- RSoft's DiffractMOD, a 3D full-vector RCWA-based simulator, allows users to freely change the incident conditions such as angle, polarization, or phase
  - For a fixed launch angle ( $\phi=53.9^\circ$ ), a theta scan can be performed to find optimal transmission/reflection:

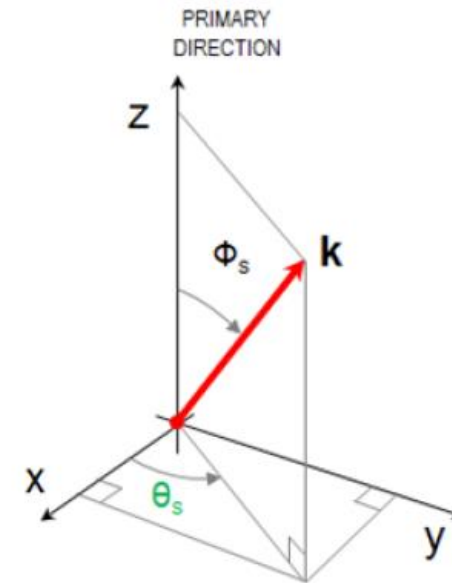
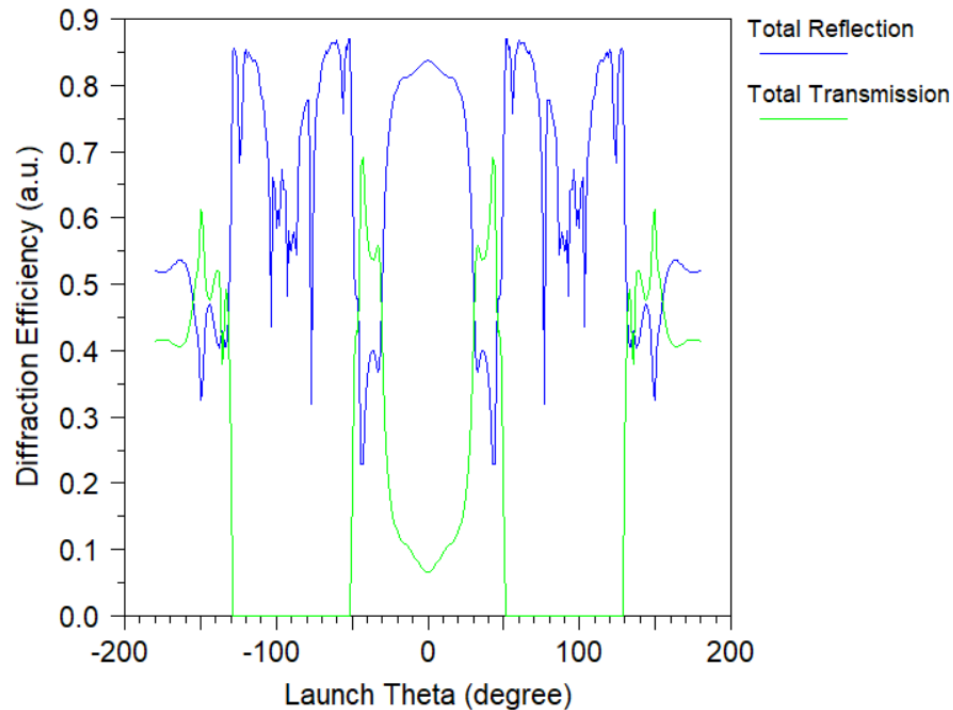

# Optical System in LightTools

- RSoft BSDF files for each grating were used to define the surface properties of the appropriate area in LightTools:
  - Users are able to rotate the axes of optical properties to achieve the tilted grating profile

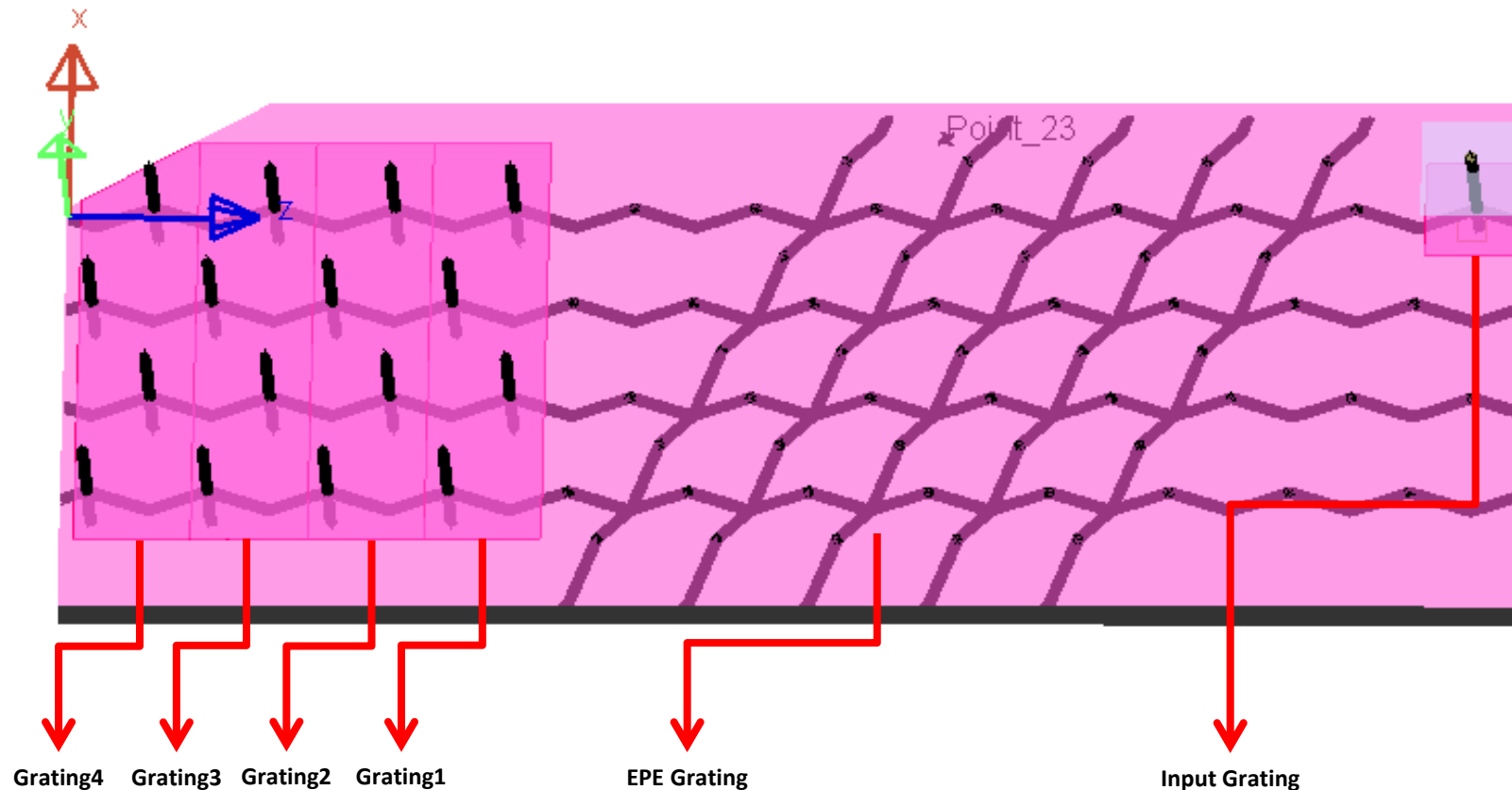

# Optical System in LightTools

- Data in the output plane shows 16 beams after propagating through the input grating, EPE grating and four output gratings
  - One beam is coupled into substrate
  - 4 beams are generated by EPE
  - 16 beams are coupled out
- Uniformity of the output beams can be further improved by optimizing the EPE grating

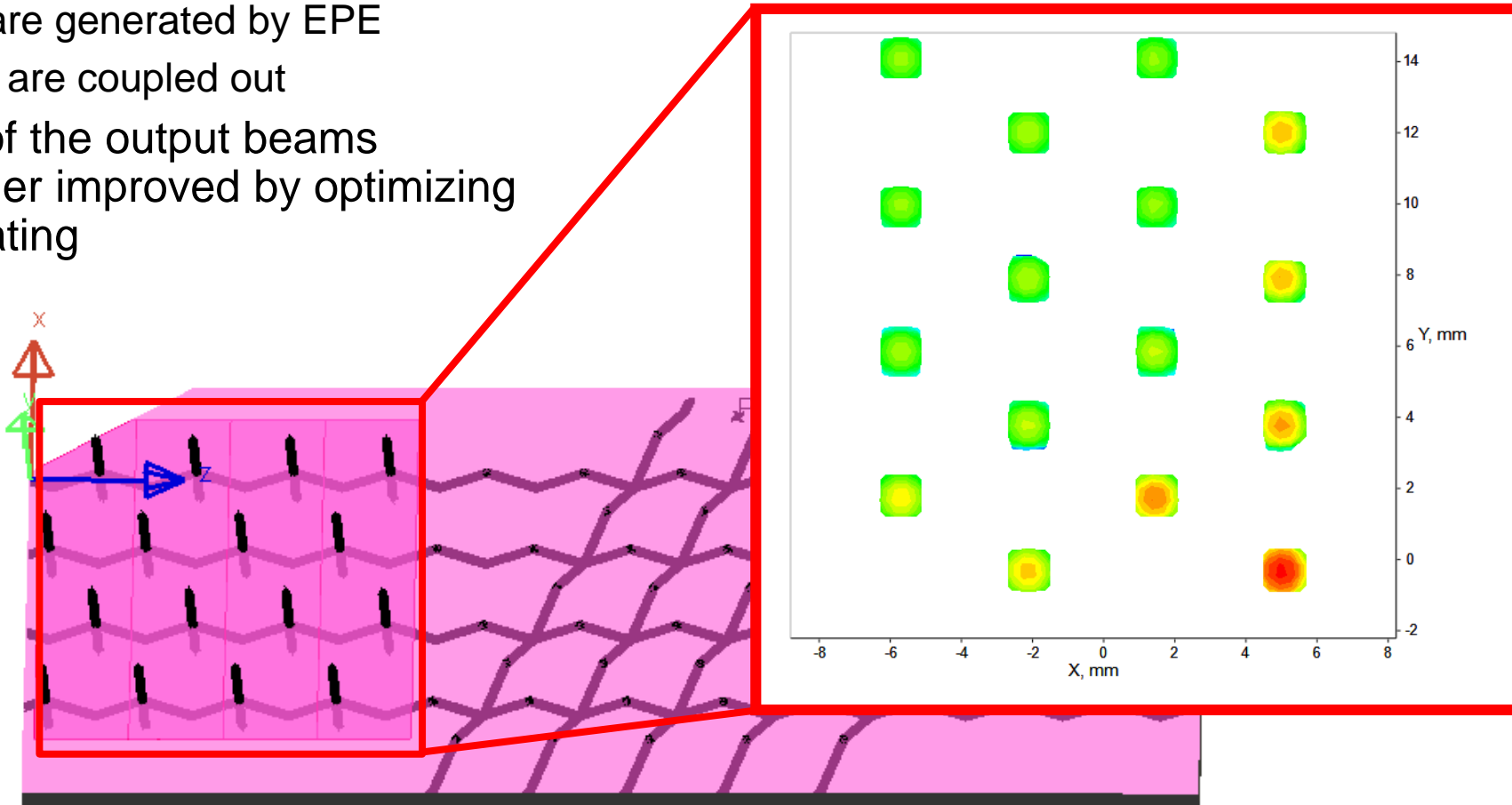

# Conclusion

- Synopsys provides a complete set of tools to study AR/VR devices

- **Workflow:**

- RSoft (grating design and optimization) → BSDF interface → LightTools (optics systems design)

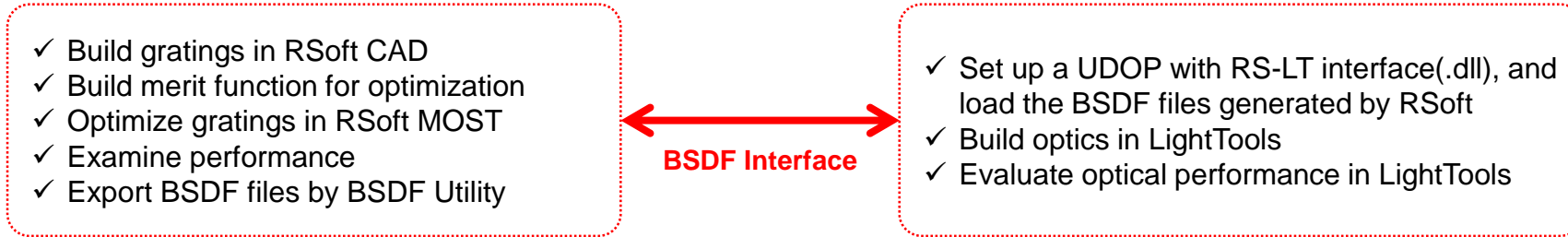

- **Design and Optimization of Gratings:**

- Gratings can be optimized based on diffraction angle, efficiencies, etc. of any order or combination of orders
- MOST Optimization in RSoft CAD provides a convenient method to optimize gratings with either FullWAVE or DiffractMOD

- **Data Processing:**

- No extra work to use RSoft BSDF data in Synopsys' LightTools
- All diffractive properties are included in the RSoft BSDF files, including R/T, dispersion, polarization, etc

- **Manufacture:**

- Users are able to export layout files from RSoft directly, and manufacture gratings in a suitable process